

# **Flight and Operation Manual for Gyroplane MTOsport**

INTENTIONALLY LEFT BLANK

# Flight and Operation Manual for Gyroplane MTOsport

Model: \_\_\_\_\_

Serial number: \_\_\_\_\_

Registration: \_\_\_\_\_

Type certificate number: \_\_\_\_\_

Aircraft manufacturer and  
type certificate holder:

AutoGyro GmbH  
Dornierstraße 14  
D-31137 Hildesheim  
Tel.: +49 (0) 51 21 / 8 80 56-00  
Fax: +49 (0) 51 21 / 8 80 56-19

Distribution partner: \_\_\_\_\_

\_\_\_\_\_

\_\_\_\_\_

Owner: \_\_\_\_\_

\_\_\_\_\_

\_\_\_\_\_

This flight manual is always to be carried on board of the aircraft and must be kept in current, up-to-date status. The latest revisions and version status is available at [www.auto-gyro.com](http://www.auto-gyro.com). Extent and revision status of the manual is recorded in the revision log and the table of contents.

This gyroplane may be operated only in strict compliance with the limitations and procedures contained in this manual.

**The manual is not a substitute for competent theoretical and practical training on the operation of this aircraft. Failure to adhere to its provisions or to take proper flight instruction can have fatal consequences.**

## Applicability

This manual is applicable for MTOsport models from a manufacturing date 15.02.2011 and on. For earlier models please refer to manual version 4.x which will be maintained in current status and revised, if necessary.

## REVISION LOG

Rev.	Inserted by	Date	Signature
5.0	AutoGyro	01.04.2011	
5.1	AutoGyro	01.10.2011	
5.2	AutoGyro	01.04.2012	



## CONTENTS

### SECTION 1 - GENERAL

1.1	Introduction.....	1-1
1.2	Certification .....	1-1
1.3	Performance Data and Operating Procedures .....	1-1
1.4	Definition of Terms .....	1-2
1.5	Important Note.....	1-2
1.6	Three-view of the MTOsport .....	1-3
1.7	Description .....	1-4
1.8	Technical Data .....	1-4
1.9	Rotor .....	1-4
1.10	Engine .....	1-5
1.11	Propeller.....	1-6
1.12	Unit Conversion.....	1-6
1.13	Abbreviations and Terminology .....	1-7

### SECTION 2 - LIMITATIONS

2.1	General .....	2-1
2.2	Environmental Limitations.....	2-2
2.3	Colour Code for Instrument Markings .....	2-2
2.4	Airspeed Limitations and Instrument Markings.....	2-3
2.5	Rotor Speed Limitations and Instrument Markings .....	2-3
2.6	Powerplant Limitations and Instrument Markings.....	2-4
2.7	Weight and Balance .....	2-6
2.8	Flight Crew .....	2-7
2.9	Kinds of Operation.....	2-7
2.10	Fuel.....	2-8
2.11	Minimum Equipment.....	2-8
2.12	Placards .....	2-9

### SECTION 3 - EMERGENCY PROCEDURES

3.1	Engine Failure .....	3-1
3.2	Air Restart Procedure .....	3-2
3.3	Landing into Trees or High Vegetation.....	3-2
3.4	Degradation of Engine Power .....	3-2
3.5	Evacuating the Aircraft.....	3-3
3.6	Engine Fire.....	3-3
3.7	Off-field Landing .....	3-4
3.8	Flight Control Malfunction .....	3-4
3.9	Warning Lights .....	3-5
3.10	Parameters out of Limits.....	3-6
3.11	Recovery System / Rotor System .....	3-6
3.12	Rotor Icing.....	3-6
3.13	Landing with a Deflated Tyre .....	3-6



3.14	Failure of Variable Pitch Propeller (if installed) .....	3-7
3.15	Alternative Method of Engine Shut-down .....	3-8
<b>SECTION 4 - NORMAL PROCEDURES</b>		
4.1	Airspeeds for Safe Operation .....	4-1
4.2	Preparation for Flight .....	4-1
4.3	Daily or Pre-flight Checks .....	4-1
4.4	Before Boarding .....	4-5
4.5	Before Starting Engine .....	4-5
4.6	Starting Engine .....	4-6
4.7	Taxi and Run-up .....	4-7
4.8	Take-off Procedure .....	4-7
4.9	Take-off Run .....	4-9
4.10	Climb .....	4-9
4.11	Cruise .....	4-9
4.12	Descent .....	4-10
4.13	Approach .....	4-10
4.14	Landing .....	4-10
4.15	Go-around .....	4-11
4.16	After Landing .....	4-11
4.17	Engine Shut-down .....	4-12
4.18	Parking .....	4-12
4.19	Special Procedure: Short Field Take-off .....	4-12
4.20	Special Procedure: Slow Speed Sink and Recovery .....	4-12
4.21	Training Engine In-flight Shut-down and Air Restart .....	4-13
4.22	Noise Abatement .....	4-13
<b>SECTION 5 - PERFORMANCE</b>		
5.1	Demonstrated Operating Temperature .....	5-1
5.2	Airspeed Calibration .....	5-1
5.3	Height-Velocity Diagram .....	5-2
5.4	Speeds .....	5-3
5.5	Rate of Climb .....	5-3
5.6	Take-off and Landing Data .....	5-3
5.7	Influence on Take-off Distance and Climb Rate .....	5-4
5.8	Glide Ratio .....	5-5
5.9	Additional Performance Data .....	5-6
5.10	Sound Exposure Level / Noise Characteristics .....	5-6
<b>SECTION 6 - WEIGHT AND BALANCE</b>		
6.1	General .....	6-1
6.2	Weight and Balance Record .....	6-1
6.3	Compliance with Weight and Balance .....	6-1
<b>SECTION 7 - SYSTEM DESCRIPTION</b>		
7.1	Introduction .....	7-1
7.2	Airframe and Undercarriage .....	7-1
7.3	Doors, Windows and Exits .....	7-1



7.4	Fuel System .....	7-1
7.5	Pneumatic System.....	7-3
7.6	Power Plant.....	7-4
7.7	Propeller.....	7-4
7.8	Rotor System.....	7-5
7.9	Flight Controls .....	7-5
7.10	Electrical System.....	7-7
7.11	Lighting System.....	7-7
7.12	Instrument Panel .....	7-8
7.13	Intercom .....	7-13
7.14	Pitot Static.....	7-13
7.15	Indicators and Sensors.....	7-13
7.16	Seats and Seatbelts .....	7-13
7.17	Stowage Capacity.....	7-13
<b>SECTION 8 - HANDLING AND SERVICING</b>		
8.1	Maintenance Obligations .....	8-1
8.2	General .....	8-1
8.3	Ground Handling .....	8-2
8.4	Cleaning .....	8-2
8.5	Refuelling .....	8-2
8.6	Checking of Engine Oil Level.....	8-2
8.7	Checking of Engine Coolant Level.....	8-3
8.8	Tire Pressure.....	8-3
8.9	Lubrication and Greasing.....	8-3
8.10	Replenishing of Fluids .....	8-4
8.11	Engine Air Filter.....	8-4
8.12	Propeller.....	8-4
8.13	Battery.....	8-4
8.14	Winter Operation .....	8-4
8.15	Removal, Disassembly, Assembly and Installation of the Rotor .....	8-5
8.16	Road Transport .....	8-8
8.17	Repairs.....	8-9
<b>SECTION 9 - SUPPLEMENTS</b>		
9-1	Variable Pitch Propeller - IVO	
9-2	Lights	
9-3	GPS/Moving Map Systems	
<b>SECTION 10 - SAFETY TIPS</b>		
<b>APPENDIX</b>		
	Operator Registration Form	
	Customer Feedback Form	
	Incident Reporting Form	



INTENTIONALLY LEFT BLANK





## LIST OF EFFECTIVE PAGES

Page(s)	Rev.	Date
1-1 to 1-8	5.2	01.04.2012
2-1 to 2-10	5.2	01.04.2012
3-1 to 3-8	5.2	01.04.2012
4-1 to 4-13	5.2	01.04.2012
5-1 to 5-6	5.2	01.04.2012
6-1	5.2	01.04.2012

Page(s)	Rev.	Date
7-1 to 7-13	5.2	01.04.2012
8-1 to 8-9	5.2	01.04.2012
9-1 – 1 to 3	5.2	01.04.2012
9-2 – 1	5.2	01.04.2012
9-3 – 1	5.2	01.04.2012
10-1 to 10-4	5.2	01.04.2012



INTENTIONALLY LEFT BLANK

## CONTENTS

1.1	Introduction.....	1-1
1.2	Certification .....	1-1
1.3	Performance Data and Operating Procedures .....	1-1
1.4	Definition of Terms .....	1-2
1.5	Important Note.....	1-2
1.6	Three-view of the MTOsport .....	1-3
1.7	Description .....	1-4
1.8	Technical Data .....	1-4
1.9	Rotor .....	1-4
1.10	Engine .....	1-5
1.11	Propeller.....	1-6
1.12	Unit Conversion.....	1-6
1.13	Abbreviations and Terminology .....	1-7



INTENTIONALLY LEFT BLANK

## **SECTION 1 - GENERAL**

### **1.1 Introduction**

This manual is designed as an operating guide for pilots, instructors, and owners/operators, providing information for the safe and efficient operation of this gyroplane. It includes material required to be furnished to the pilot by the competent certification authority. This handbook is not designed as a substitute for adequate and competent flight instruction, however.

Pilots of this aircraft must hold a proper license including the class rating 'gyroplane', corresponding to the aircraft's registration. A special endorsement may be required to fly with passengers. It is the pilot's responsibility to be familiar with this handbook, the special characteristics of this gyroplane, and all other information and legal requirements relevant for the operation in his country. The pilot is responsible to determine the gyroplane is safe for flight, and to operate the aircraft with respect to the procedures and limitations provided in this manual.

It is the owner's/operator's responsibility to have this gyroplane registered and insured, according to country-specific regulations. The aircraft owner/operator is also responsible for maintaining the gyroplane in airworthy condition. Maintenance instructions are provided in the Maintenance Manual and in SECTION 8 of this manual. Note that depending on the kind of operation, type of maintenance activity, or component involved, the competent authority may dictate qualified personnel and/or respective facilities.

### **1.2 Certification**

The MTOsport is designed, tested and certified according to the German design specifications for microlight gyroplanes ("Bauvorschriften für Ultraleichte Tragschrauber", BUT 2001) including its latest amendment published in "Nachrichten für Luftfahrer" NfL II 13/09 issued 12.02.2009, as well as the British Civil Airworthiness Requirements (BCAR) Section T.

The corresponding certification documents (Geräte-Kennblatt) have been issued by the responsible Germany department DULV (Deutscher Ultraleichtflugverband e.V.), respectively the German national certifying authority.

The noise certificate was granted according to the German requirements for noise protection for microlight gyroplanes ("Lärmschutzverordnung für Ultraleichte Tragschrauber").

### **1.3 Performance Data and Operating Procedures**

The legal basis for operating a gyroplane is provided by national law and its respective regulations. The instructions and conditions contained have to be considered when operating the gyroplane.

All documented performance data and operating procedures have been identified within the certification processes for this gyroplane by means of flight test and analysis.

## 1.4 Definition of Terms

This manual uses **WARNINGS**, **CAUTIONs** and **NOTEs** in bold capital letters to indicate especially critical and important instructions. Additionally, the colour of the panel (red, yellow, and grey shading) highlights the significance of the instruction. Definitions for each term are given below.

### WARNING

A warning means that the neglect of the appropriate procedure or condition could result in personal injury or loss of life.

### CAUTION

A caution means that the neglect of the appropriate procedure or condition could result in damage to or destruction of equipment.

### NOTE

A note stresses the attention for a special circumstance, which is essential to emphasize.

## 1.5 Important Note

Before each flight pilots must make themselves familiar with the appropriate navigational, weather and safety information pertinent to their planned route.

The limitations provided in SECTION 2 of this manual must be respected at all times. Check the manufacturer's web site [www.auto-gyro.com](http://www.auto-gyro.com) regularly for flight manual updates, airworthiness directives, service bulletins, or safety information.

Abrupt manoeuvres or flight in heavy turbulence must be avoided as this could lead to rotor speed variations associated with high stress, possible damage to the aircraft, or uncontrollable attitudes.

### 1.6 Three-view of the MTOsport

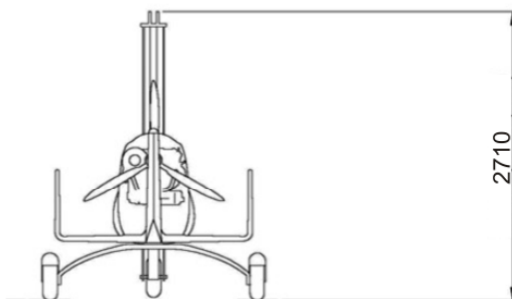
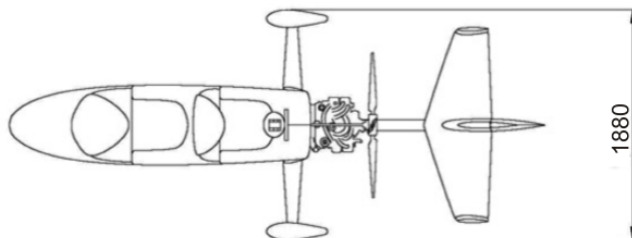
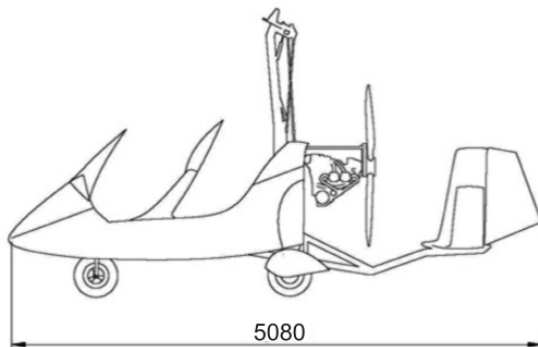

## 1.7 Description

### General Characteristics

- Gyroplane with nose gear wheel chassis
- Framework manufactured from inert-gas welded stainless steel tube
- Two-seat tandem configuration
- Main landing gear with GRP (glass fibre reinforced plastic) spring spar and hydraulic disc brakes
- Extruded aluminium rotor
- Rotor head controlled with connecting rods
- Rudder controlled with cables
- Rudder and stabilizer surfaces made of GRP (or carbon fibre)

## 1.8 Technical Data

Length: .....	5.08 m
Width: .....	1.88 m
Height: .....	2.71 m
Empty weight: .....	240.8 to 247.0 kg
Payload: .....	209.2 to 203.0 kg
Take-off weight/mass (max.):.....	450.0 kg
Fuel tank capacity: .....	34 ltr
(with optional auxiliary fuel tank installed) .....	68 ltr

## 1.9 Rotor

### General

Type: .....	2-bladed, fixed pitch, free to teeter
Material: .....	EN AW 6005A T6 aluminium extrusion
Blade profile: .....	NACA 8H12

### Standard rotor

Rotor diameter.....	8.4 m
Rotor disc area .....	55.4 sqm
Rotor disc load .....	8.1 kg/sqm

### Sport rotor

Rotor diameter.....	8.0 m
Rotor disc area .....	50.3 sqm
Rotor disc load .....	8.9 kg/sqm



## 1.10 Engine

### ROTAX 912 ULS

- 4-cylinder, four-stroke spark-ignition engine with opposed cylinders
- Liquid cooled cylinder heads
- Air cooled cylinders
- Dry sump forced lubrication with separate oil tank
- Automatic adjustment by hydraulic valve tappet
- 2 carburettors
- Mechanical fuel pump
- Electronic dual ignition
- Propeller speed reduction unit, engine mount assembly
- Electric starter (12V 0,6kW)
- Air intake system, exhaust system

### ROTAX 914 UL

- 4-cylinder, four-stroke spark-ignition engine with opposed cylinders with turbo charger
- Liquid cooled cylinder heads
- Air cooled cylinders
- Dry sump forced lubrication with separate oil tank
- Automatic adjustment by hydraulic valve tappet
- 2 carburettors
- Electronic dual ignition
- Propeller speed reduction unit, engine mount assembly
- Electric starter (12V 0,6kW)
- Air intake system, exhaust system

## 1.11 Propeller

### HTC 3 Blade

Airscrew with ground adjustable pitch made of CRP / GRP

Model ..... HTC 3 Blade 172 ccw 3B

Number of blades ..... 3

Diameter ..... 172 cm

In-flight pitch adjustment ..... none

### IVO Prop

Airscrew with in-flight adjustable pitch made of CRP / GRP

Model ..... IVO Prop medium ccw 3B

Number of blades ..... 3

Diameter ..... 172 cm

In-flight pitch adjustment ..... electric, continuous adjustable

## 1.12 Unit Conversion

<b>Multiply</b>	<b>by</b>	<b>to obtain</b>
kts (knots)	1.852	km/h
km/h (kilometres per hour)	0.54	kts
mph (miles per hour)	1.61	km/h
km/h (kilometres per hour)	0.62	mph
ft (feet)	0.305	m
m (metres)	3.28	ft

### 1.13 Abbreviations and Terminology

<b>ACL</b>	Anti-Collision Light
<b>AGL</b>	Above Ground Level
<b>ATC</b>	Air Traffic Control
<b>CAS</b>	Calibrated AirSpeed – indicated speed corrected for installation errors
<b>ccw</b>	Counter Clock Wise
<b>CG</b>	Centre of Gravity
<b>CHT</b>	Cylinder Head Temperature
<b>CRP</b>	Carbon Reinforced Plastic
<b>CSP</b>	Constant Speed Propeller
<b>DA</b>	Density Altitude
<b>DULV</b>	Deutscher UltraLeichtflugVerband e.V.
<b>Empty Wt</b>	Empty Weight of the gyroplane including oil, cooling liquid and unusable fuel
<b>FOM</b>	Flight and Operation Manual
<b>G / g</b>	G-loading as a factor of gravity
<b>GEN</b>	Generator
<b>GPS</b>	Global Positioning System
<b>GRP</b>	Glass Reinforced Plastic
<b>H/V</b>	Height-Velocity
<b>IAS</b>	Indicated AirSpeed – airspeed values in this manual refer to indicated air speed
<b>ICAO</b>	International Civil Aviation Organization
<b>In Hg</b>	(Manifold) Pressure, corresponding to inch mercury
<b>ISA</b>	International Standard Atmosphere
<b>JNP</b>	JahresNachPrüfung – Annual Inspection
<b>LED</b>	Light Emitting Diode
<b>LH</b>	Left-Hand
<b>LOEP</b>	List Of Effective Pages
<b>ltr</b>	Litre
<b>MAP</b>	Manifold Absolute Pressure
<b>MCP</b>	Maximum Continuous Power
<b>MTOW</b>	Maximum Take-Off Weight (mass)
<b>OAT</b>	Outside Air Temperature
<b>PA</b>	Pressure Altitude
<b>RBT</b>	Rotor Bearing Temperature
<b>RH</b>	Right-Hand
<b>ROZ</b>	Research OktanZahl– means: Octane Number
<b>RPM</b>	Revolutions Per Minute
<b>sqm</b>	Square metres
<b>TAS</b>	True AirSpeed – calibrated airspeed corrected for air density
<b>TCU</b>	Turbo Control Unit (engine)



<b>TOC</b>	Table Of Contents
<b>TOP</b>	Take-Off Power
<b>V<sub>A</sub></b>	Design maneuvering speed
<b>V<sub>B</sub></b>	Design speed for maximum gust intensity
<b>VFR</b>	Visual Flight Rules
<b>V<sub>H</sub></b>	Maximum level-flight speed at maximum continuous power
<b>V<sub>Hmin</sub></b>	Minimum level-flight speed
<b>V<sub>NE</sub></b>	Never-Exceed Speed – maximum speed that must never be exceeded
<b>VOX</b>	Voice Operated eXchange, means: voice activation (level)
<b>VPP</b>	Variable Pitch Propeller
<b>VSI</b>	Vertical Speed Indicator
<b>V<sub>X</sub></b>	Speed for best angle of climb
<b>V<sub>Y</sub></b>	Speed for best rate of climb and maximum endurance
<b>W&amp;B</b>	Weight and Balance

## CONTENTS

2.1	General .....	2-1
2.2	Environmental Limitations.....	2-2
2.3	Colour Code for Instrument Markings .....	2-2
2.4	Airspeed Limitations and Instrument Markings.....	2-3
2.5	Rotor Speed Limitations and Instrument Markings.....	2-3
2.6	Powerplant Limitations and Instrument Markings.....	2-4
2.7	Weight and Balance .....	2-6
2.7.1	Weight Limits .....	2-6
2.7.2	Centre of Gravity (CG) Limits.....	2-6
2.7.3	Demonstrated Structural Load Factors.....	2-6
2.8	Flight Crew .....	2-7
2.9	Kinds of Operation.....	2-7
2.10	Fuel.....	2-8
2.10.1	Approved Fuel Grades.....	2-8
2.10.2	Fuel Tank Capacities .....	2-8
2.10.3	Unusable Fuel.....	2-8
2.11	Minimum Equipment.....	2-8
2.12	Placards .....	2-9



INTENTIONALLY LEFT BLANK

## SECTION 2 - LIMITATIONS

This section contains operating limitations, instrument markings and basic placards which are required for safe operation of the gyroplane, including its engine, and standard equipment or systems.

### 2.1 General

#### WARNING

The operation of a gyroplane demands professional pilot instruction and dedicated training on gyroplanes. Without a valid license the gyroplane must not be operated.

#### WARNING

During the entire flight adequate rotor loading must be maintained. Do not perform any manoeuvres resulting in the sensation of feeling light or near weightless.

#### WARNING

Smoking on board is prohibited!

#### CAUTION

This gyroplane has been designed and tested for a safe design load of 3g at maximum gross mass. Note that flying at higher speeds in turbulent air, especially in combination with aggressive manoeuvres or a steep turn, can easily create higher loads on the aircraft.

#### NOTE

This gyroplane does not comply with the terms of the international authority for civil aviation (ICAO). Therefore, it is not possible to operate it in international air traffic unless specific intergovernmental agreements allow doing so. The reason for this is that there is no international common basis for gyroplanes.

**NOTE**

During the certification process all required safe loads have been successfully demonstrated. However, the gyroplane may be exposed to much higher loads especially when operated on rough surfaces, such as an unprepared grass strip. In this case it is even more essential to perform a thorough pre-flight inspection and have components and parts exchanged, where needed.

## 2.2 Environmental Limitations

Maximum wind speed or gust intensity .....	40 kts
Maximum demonstrated crosswind component for take-off and landing ...	20 kts
Maximum tailwind component for take-off and landing.....	5 kts
Temperature.....	- 20 to + 40 °C

**WARNING**





Do not consider flying in the likelihood of severe weather. Thunderstorms may develop rapidly with the risk of heavy precipitation or hail, severe turbulence with strong vertical air movements, and lightning strike. If, despite proper flight planning, a thunderstorm should be encountered, consider a precautionary landing to avoid the squall line. A lightning strike may damage the main rotor bearing. Thorough inspection and maintenance after lightning strike must be performed.

## 2.3 Colour Code for Instrument Markings

<b>Red</b>	Operating limits. Pointer should not enter red during normal operation
<b>Yellow</b>	Precautionary or special operating procedure range
<b>Green</b>	Normal operating range



## 2.4 Airspeed Limitations and Instrument Markings

Air Speed	Marking	
$V_{NE}$ Never Exceed Speed	Red radial	 <b>185 km/h</b>
	Yellow arc	 120 – 185 km/h
$V_A$ max. design maneuvering speed $V_B$ design speed for max. gust intensity	Green arc	 30 - <b>120 km/h</b>
	Yellow arc	 0 – 30 km/h





### WARNING

The maximum speed  $V_{NE}$  must never be exceeded!

### WARNING

Sudden or large control input to the front must be avoided at all means, even at speeds below design maneuvering speed  $V_A$  test. Do not exceed  $V_B$  when flying through turbulence, gusts or rough winds!

## 2.5 Rotor Speed Limitations and Instrument Markings

Rotor Speed	Marking	
<b>Rotor speed limit</b>	Red radial	 <b>610 RPM</b>
Rotor speed caution range	Yellow arc	 550 – 610 RPM
Continuous rotor speed	Green arc	 200 – 550 RPM
<b>Maximum pre-rotation speed</b>	Yellow radial	 <b>240 RPM</b>

## 2.6 Powerplant Limitations and Instrument Markings

Engine Speed	Marking	
Maximum engine speed	Red radial	<b>5800 RPM</b>
5 minute take-off power regime	Yellow arc	5500 – 5800 RPM
Maximum continuous power	Green arc	1400 – <b>5500 RPM</b>
	Yellow arc	0 – 1400 RPM



Engine Oil Temperature	Marking	
Maximum oil temperature	Red radial	<b>130 °C</b>
	Yellow arc	110 – 130 °C
Maximum continuous oil temperature	Green arc	90 – <b>110 °C</b>
	Yellow arc	50 – 90 °C
Minimum oil temperature	Red radial	<b>50 °C</b>



  

Cylinder Head Temperature	Marking	
Maximum cylinder head temperature	Red radial	<b>135 °C</b>
	Green arc	50 – 135 °C

Engine Oil Pressure	Marking	
Maximum oil pressure	Red radial	<b>7 bar</b>
	Yellow arc	5 – 7 bar
Maximum continuous oil pressure	Green arc	2 – <b>5 bar</b>
	Yellow arc	0.8 – 2 bar
Minimum oil pressure	Red radial	<b>0.8 bar</b>

Manifold Pressure* ROTAX 912 ULS	Marking	
Maximum manifold pressure	Red radial	 31 In Hg
	Yellow arc	 27 – 31 In Hg
Maximum continuous MAP	Green arc	 0 - 27 In Hg

Manifold Pressure* ROTAX 914 UL	Marking	
Maximum manifold pressure	Red radial	 39 In Hg
	Yellow arc	 31 – 39 In Hg
Maximum continuous MAP	Green arc	 0 - 31 In Hg

\* Applicable only if installed, MAP gauge is optional equipment and recommended in conjunction with an adjustable pitch propeller. MAP limits do not apply at engine speeds above 5100 RPM, marked by a yellow triangle at the RPM gauge / engine speed indicator.

## 2.7 Weight and Balance

### 2.7.1 Weight Limits

Maximum take-off weight (MTOW): .....450 kg

#### CAUTION

**The take-off weight is the total weight of the gyroplane including empty weight, optional/additional equipment, occupants, fuel, and luggage at take-off. The maximum value specified above must never be exceeded.**

Maximum weight in front seat: ..... 125 kg

Minimum weight in front seat: .....60 kg

Maximum weight in aft seat: .....129 kg

#### NOTE

**Pilots in the front seat weighing less than 60 kg must carry corresponding ballast.**

#### Storage compartment in nose section

Maximum weight in storage compartment..... 10 kg

#### NOTE

**Any loading in the storage compartment reduces the maximum weight in front seat by factor of 3.**

**Example:** With the storage compartment loaded to the limit of 10 kg the maximum allowed weight in the front seat is reduced to 95 kg.

### 2.7.2 Centre of Gravity (CG) Limits

The centre of gravity is considered to be within limits if all weight limits above are respected. For details see SECTION 6 of this manual.

### 2.7.3 Demonstrated Structural Load Factors

Demonstrated positive load factor (500 kg)..... + 3 g

Demonstrated negative load factor (500 kg) – structural limit..... - 1 g

**Important note:** the indication of a demonstrated negative load factor represents a structural limit only. In flight, the limitations (see 2.9) have to be respected at all times.

## 2.8 Flight Crew

Minimum crew is one pilot in the front seat.

Harness in aft seat must be fastened and tight.

The aft control stick must be removed unless the passenger seat is occupied by a qualified flight instructor.

## 2.9 Kinds of Operation

Only day VFR operation is approved!

Aerobatic flight is prohibited!

### NOTE

**Manoeuvres involving bank angles of more than 60° are considered to be aerobatic flight.**

Low-G manoeuvres are prohibited!

### WARNING

**Any maneuver resulting in a low-G (near weightless) condition can result in a catastrophic loss of lateral/roll control in conjunction with rapid main rotor RPM decrease. Always maintain adequate load on the rotor and avoid aggressive forward control input performed from level flight or following a pull-up.**

Excessive side-slip is prohibited!

### WARNING

**Side slip may be performed only with proper training and within safe boundaries. Use gentle pedal input for initiation and stabilization. Do not rely on airspeed indication in side slip. Never perform abrupt control stick input into the direction of motion. Be aware that excessive side slip may result in an uncontrollable and unrecoverable (low-G) attitude.**

Flight in icing conditions is prohibited!

**NOTE**

**Icing may occur even at temperatures above freezing!**

Operation in strong gusts or wind speeds of more than 72 km/h (40 kts) is prohibited!

## 2.10 Fuel

### 2.10.1 Approved Fuel Grades

**Preferred fuel**

EN 228 Super or EN228 Super plus (min. ROZ 95)

**Alternate fuel**

AVGAS 100 LL (ASTM D910)

For operational constraints and maintenance aspects when using preferred fuel and alternate fuel, refer to the engine manufacturer's manual.

### 2.10.2 Fuel Tank Capacities

Maximum tank capacity, standard tank..... 34 ltr

Maximum tank capacity, with optional auxiliary fuel tank..... 68 ltr

### 2.10.3 Unusable Fuel

Unusable fuel quantity, standard tank..... 2 ltr

Unusable fuel quantity, with optional auxiliary fuel tank..... 4 ltr

**NOTE**

**The amount of unusable fuel is dependent on the attitude of the gyroplane. A forward centre of gravity (heavy weight in front seat and/or storage compartment) or nose-down attitudes will increase the quantity of unusable fuel.**

## 2.11 Minimum Equipment

The following equipment must be operative for flight:

- Air speed indicator
- Altimeter
- Compass
- Rotor RPM indicator
- Engine instruments (oil pressure, RPM, CHT)
- Perrotator

## 2.12 Placards

In clear view of the pilot:

**Only VFR day is approved**  
**Aerobatic flight prohibited!**  
**Low-G manoeuvres prohibited!**  
**Flight in icing conditions prohibited!**  
**Max. gusts/wind 72 km/h (40 kts)!**

In clear view of the pilot:

**Max. gross weight:** \_\_\_\_\_  
**Empty weight:** \_\_\_\_\_  
**Max. useful load:** \_\_\_\_\_

At front seat:

**Max. weight in seat:** 125 kg  
**Min. weight in seat:** 60 kg

At aft seat:

**Max. weight in seat:** 129 kg

**Solo from front seat only**

Occupant warning (front and aft seat):

**OCCUPANT WARNING**  
**This aircraft has not been certified**  
**to an international requirement**

At storage compartment in nose section:

**Max. load: 10 kg**  
**W&B must be respected!**

At fuel filler neck:

**Min. ROZ 95**  
**AVGAS 100LL**

At each fuel tank:

**Capacity 34 litres**

At fuel shut-off valve (if installed):

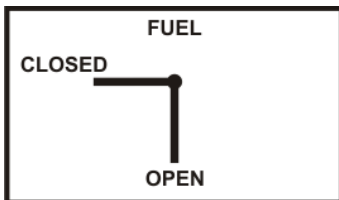

At both static ports (if installed):

**Static Port**  
**Do not obstruct!**



## CONTENTS

3.1	Engine Failure .....	3-1
3.2	Air Restart Procedure .....	3-2
3.3	Landing into Trees or High Vegetation.....	3-2
3.4	Degradation of Engine Power .....	3-2
3.5	Evacuating the Aircraft.....	3-3
3.6	Engine Fire.....	3-3
3.7	Off-field Landing .....	3-4
3.8	Flight Control Malfunction .....	3-4
3.8.1	Engine Power Control / Throttle .....	3-4
3.8.2	Rudder Malfunction.....	3-4
3.8.3	Rotor Head Control.....	3-5
3.9	Warning Lights .....	3-5
3.9.1	GEN or Low Volt Indicator Light.....	3-5
3.9.2	Low Volt.....	3-5
3.9.3	BOOST WARN Light (red) - only ROTAX 914 UL .....	3-5
3.9.4	BOOST CAUTION Light (orange) - only ROTAX 914 UL .....	3-5
3.10	Parameters out of Limits.....	3-6
3.11	Recovery System / Rotor System .....	3-6
3.12	Rotor Icing.....	3-6
3.13	Landing with a Deflated Tyre .....	3-6
3.14	Failure of Variable Pitch Propeller (if installed).....	3-7
3.15	Alternative Method of Engine Shut-down .....	3-8



INTENTIONALLY LEFT BLANK

## SECTION 3 - EMERGENCY PROCEDURES

This chapter contains the check lists and procedures to be executed in emergency situations.

Emergencies due to defects of the gyroplane or its engine are extremely seldom if the aircraft is checked thoroughly before each flight and continuously maintained. If there should occur a case of emergency anyhow, the guidelines of this chapter are to be followed in order to manage the emergency.

This gyroplane, like most recreational air vehicles, is fitted with a non-certified engine. This means that there may be a higher risk of engine failure than with a certified aircraft engine, with the associated risks of damage or injury as the result of an unplanned landing. Therefore strict compliance with the engine manufacturer's maintenance schedules, operational procedures and any additional instructions is essential. The aircraft must always be flown with the risk of engine failure in mind, and must not be flown over any areas where a forced landing cannot be safely executed.

### 3.1 Engine Failure

In case of an engine failure the following action is recommended:

#### Engine failure during take-off run

- Maintain directional control using sensitive but appropriate pedal input
- With the rotor/stick remaining aft, let gyroplane decelerate. Wheel brakes may be used to assist
- At walking speed level-off rotor disc, use wheel brakes and bring rotor to a stop

#### Engine failure after lift-off and below 150 ft AGL

- The climb-out should be performed according to the Height-Velocity-Diagram in CHAPTER 5
- When engine failure occurs, immediately lower nose to enter glide attitude
- Continue straight ahead – a 180° turn back to the airfield may be a bad option
- Maintain airspeed until ground is approached, then perform flare
- Depending on final approach speed be prepared to flare more distinctly than normal

#### Engine failure at or above 150 ft AGL

- Consider wind speed and direction
- Select a suitable landing site
- If time allows, a restart may be attempted, see "Air restart procedure" below
- Perform a landing into wind and/or upslope if possible
- Prior to touch-down switch OFF Main Switch

### WARNING

**Always plan your route to remain within safe gliding distance to areas where a safe forced landing can be performed in case of an engine failure. A landing in high trees or open waters may end fatally.**

**NOTE**

The best engine-off glide ratio is about 1:3 at 100 km/h. Depending on a possible headwind the glide may be extended by slightly increasing airspeed. It is heavily recommended to train your forced landing capabilities regularly, preferably with a qualified flight instructor.

**3.2 Air Restart Procedure**

- Check fuel valve OPEN (if installed)
- Check fuel pump(s) ON
- Check both magnetos ON
- Throttle slightly open
- With the left hand, turn the Main Switch/Starter key completely to OFF, then START
- If possible, allow engine and oil to warm-up before full power is applied

**NOTE**

The starter interlock function prevents inadvertent starter engagement. Before attempting an engine start, the interlock must be reset by turning the Main Switch/Starter key to OFF.

**3.3 Landing into Trees or High Vegetation**

- Assume the surface of the treetops or vegetation as level
- Plan touch-down and flare with minimum ground speed and minimum rate of descent
- As soon as the wheels contact the vegetation bring the rotor disc to level attitude to avoid partial blade tip contact with vegetation
- Shut down engine by switching magnetos OFF and master switch OFF

**3.4 Degradation of Engine Power**

A gradual decay in engine RPM, accompanied by a rough running engine or even vibration may be an indicator for carburettor icing. In this case, continue with a high power setting and change altitude into air which is less susceptible to carburettor icing.

If the situation cannot be corrected be prepared for further loss of power and ultimately engine failure.

**NOTE**

The phenomenon of carburettor icing is extremely unlikely with this engine type as it is fitted with a hot water heated jacket around the carburettor inlets. Note that the system can work properly only when the engine is at operating temperature.

### 3.5 Evacuating the Aircraft

In normal circumstances occupants should never leave the aircraft while the propeller or the rotors are turning. If abandoning the aircraft in an emergency the pilot should turn off the engine magneto switches and turn the master switch to "OFF" if this can be done without endangering the occupants.

If abandoning the aircraft with either the propeller and/or the rotors turning the occupants should follow a path in line with the nose of the aircraft, to minimise the risk of being struck by either the rotor or the propeller.

Occupants should be briefed before flight on emergency evacuation procedures, including:

- Actions to be taken in the event of a forced landing
- Operation of the seat harness
- Disconnection of any intercom leads or other connections to the aircraft
- How to safely exit and move away from the aircraft

### 3.6 Engine Fire

In case of fire the following action is recommended:

**Fire on ground**

- Both magnetos OFF and master switch OFF to shut-down engine and fuel pumps
- Evacuate aircraft
- Close fuel shut-off valve if situation allows
- Extinguish fire and have damage inspected

**Fire in flight**

- Immediately initiate an emergency landing
- Initiate emergency call, if time and situation permits
- As soon as a power-off landing can be assured, shut down engine by switching magnetos OFF and master switch OFF
- Continue procedure as described in "Engine Failure" and "Fire on ground"

### 3.7 Off-field Landing

A precautionary landing at a non-prepared site may be performed at pilot's discretion in order to avoid unexpected weather, in case of severe illness of the pilot or a passenger, or if technical defects are suspected, for example sudden and severe rotor vibrations.

- Select a suitable landing site from safe altitude, considering slope, wind speed and direction
- Fly a reconnaissance pattern to check for obstacles, especially power lines, wires, and cables in the approach and go-around path
- Overfly the landing site to check for obstructions such as fences, ditches, rocks, height of vegetation, and select most suitable touch-down zone
- Perform a normal approach and touch-down into wind with minimal ground speed

### 3.8 Flight Control Malfunction

In case of a flight control failure the gyroplane can be controlled with the remaining primary and secondary controls, including power and trim. An immediate reduction of power, respectively speed may be necessary to avoid pitch oscillations (phugoid) or other effects affecting dynamic or static stability. Navigate to a suitable landing site with wide and shallow turns and approach against the wind.

#### 3.8.1 Engine Power Control / Throttle

##### **Throttle jammed open or max**

Navigate to a suitable landing site with the power set. If over safe terrain, magneto switches may be used to control power. When within gliding distance to the selected landing site, shut-down engine to perform a power-off landing as per Emergency Procedure "Engine failure".

#### **NOTE**

**In case of a control cable breakage the carburettor will be automatically set to full throttle position.**

##### **Throttle jammed closed**

Land as per Emergency Procedure "Engine failure". Residual power may be used to extend the glide.

#### **3.8.2 Rudder Malfunction**

In case of a stuck or loose rudder, continue flight to a suitable, preferably wide landing site that allows a landing into the wind. If necessary reduce power to avoid excessive side slip. Align gyroplane prior to touch-down, using engine torque or lateral control input to the side where the nose is pointed.

### 3.8.3 Rotor Head Control

In case of a rotor head control malfunction, control pitch attitude using careful trim input and power setting. Use rudder for directional control and for shallow turns. In some conditions it may be appropriate to reduce power/speed in order to avoid phugoid effects or a possible negative yaw-roll coupling. Approach landing site with wide and shallow turns.

## 3.9 Warning Lights

### 3.9.1 GEN or Low Volt Indicator Light

**ROTAX 912 ULS:** If any of the indicators are permanently lit, switch off all unnecessary electrical consumers and land at the nearest airfield where maintenance can be performed.

**ROTAX 914 UL:** If any of the indicators are permanently lit, switch off all unnecessary electrical consumers and perform a precautionary landing within 15 minutes. Be prepared for an engine failure.

#### NOTE

**A pulsed GEN indicator light is normal and indicates proper function of the generator.**

### 3.9.2 Low Volt

Refer to chapter above.

### 3.9.3 BOOST WARN Light (red) - only ROTAX 914 UL

#### Continuously lit

If continuously lit, the maximum admissible boost pressure was exceeded. Reduce power into normal operating range and consider restricted engine performance or boost control malfunction. Record duration and have maintenance action performed.

#### Blinking

When blinking, the allowable 5 minutes take-off power time limit has been exceeded. Reduce power into continuous range. Record duration and have maintenance action performed.

### 3.9.4 BOOST CAUTION Light (orange) - only ROTAX 914 UL

A blinking BOOST CAUTION light indicates a problem with the turbo/boost control, its sensors or the servo. Engine power is degraded and continuous operation may lead to engine damage. Perform a precautionary landing considering reduced engine performance and be prepared for engine failure.

### 3.10 Parameters out of Limits

PARAMETER	EXCURSION	CORRECTIVE ACTION
Engine Oil Temperature	Upper <b>limit</b> or <b>yellow arc</b>	Reduce power and increase air speed. If condition cannot be corrected, land as soon as practicable.
	Lower <b>limit</b>	Allow engine to warm-up on ground.
	Within lower <b>yellow arc</b>	Increase power setting, if possible. If condition prevails in normal flight, have maintenance action performed.
Cyl. Head Temperature	Upper <b>limit</b>	Reduce power and increase air speed. If condition cannot be corrected, land as soon as practicable.
Engine Oil Pressure	Upper <b>limit</b> or <b>yellow arc</b>	Reduce power. If condition cannot be corrected, have maintenance action performed prior to next flight.
	Lower <b>limit</b>	If combined with other indications, such as rising oil temperature or unusual engine behaviour, shut-down engine and perform a power-off landing as per Emergency Procedure "Engine failure". Otherwise, monitor engine instruments carefully and land as soon as practicable. Have maintenance action performed.

### 3.11 Recovery System / Rotor System

This gyroplane is not equipped with a ballistic recovery system. However, its rotor system which is in permanent autorotation serves as such a system. Therefore, the entire rotor system including its rotor head with blade attachments and the corresponding components of the flight controls have to be inspected and maintained carefully.

If any undue vibration or unusual behaviour is experienced a precautionary landing should be considered.

### 3.12 Rotor Icing

A more than normal or constantly increasing power demand may be caused by an iced-up rotor system. This could ultimately result in a condition where altitude cannot be maintained, even at maximum power. An iced-up rotor system can also cause severe vibration. If any of the signs for rotor icing is evident, carry out a precautionary landing.

### 3.13 Landing with a Deflated Tyre

Plan to land directly into the wind with minimum rate of descent at touch-down, if possible on a grass runway. Maintain directional control with adequate pedal input. Consider the use of some propeller thrust to increase rudder effectivity. Lower nose gently with the nose wheel pointing straight.



Alternatively, if landing on asphalt is unavoidable, approach normally, with the intent of a zero-speed touch-down directly into wind.

Only if impossible to recover the aircraft from the landing area it should be manoeuvred under its own power, as this could further damage the tire and wheel rim.

### 3.14 Failure of Variable Pitch Propeller (if installed)

#### Noticeable defect:

In case of a noticeable mechanical defect, indicated by sudden vibration or noise, perform a precautionary landing.

#### Run-away:

Propeller pitch changes without command, usually resulting in unexpected or sudden change in engine RPM and engine manifold pressure.

**Run-away to FINE:** RPM will increase and propeller pitch will stop in full FINE position. Reduce power if needed, to stay within RPM limits.

**Run-away to COARSE:** RPM will decrease and MAP will rise until propeller pitch stops in full COARSE position. Reduce power if needed, to stay within MAP limits.

In both cases do not try to re-engage circuit breaker until the cause of the run-away has been determined. Continue according to emergency procedure 'FREEZE'.

#### Freeze:

Propeller pitch does not react to pilot input, engine RPM does not change while propeller pitch control is activated. Proceed according to the following table:

Before take off	Do not take-off
During take-off and climb	Try to keep climbing to a safe altitude, return to the airfield and land. If the aircraft does not climb, maintain altitude and to return in a flat curve.
During cruise flight	Depending on the prop position, it should be possible to find a speed and RPM to continue the flight to the next possible landing area. Depending on the prop position your descent will look different and a go around is probably not possible.
During descent	Depending on the prop position (in case of cruise), your descent will look different and a go around will probably not be possible.
During landing	Continue approach as planned. If the prop changes to cruise and the landing looks too long, keep in mind to cut the engine.

### 3.15 Alternative Method of Engine Shut-down

If the engine continues running after the magnetos have been switched off use one of the following alternative methods:

Hold throttle lever in IDLE position firmly while overstretching the cable ends of the carburettor control cables with the other hand.

#### **Alternatively**

Engage full choke, wait a few seconds and open the throttle suddenly. This normally chokes the engine and causes it to stop

#### **Alternatively – only ROTAX 914**

Turn master switch to off to deactivate both primary and secondary electrical fuel pump. The engine will starve after approximately 30 – 60 seconds.

## CONTENTS

4.1	Airspeeds for Safe Operation.....	4-1
4.2	Preparation for Flight.....	4-1
4.3	Daily or Pre-flight Checks.....	4-1
4.4	Before Boarding.....	4-5
4.5	Before Starting Engine.....	4-5
4.6	Starting Engine.....	4-6
4.7	Taxi and Run-up.....	4-7
4.8	Take-off Procedure.....	4-7
4.9	Take-off Run.....	4-9
4.10	Climb.....	4-9
4.11	Cruise.....	4-9
4.12	Descent.....	4-10
4.13	Approach.....	4-10
4.14	Landing.....	4-10
4.15	Go-around.....	4-11
4.16	After Landing.....	4-11
4.17	Engine Shut-down.....	4-12
4.18	Parking.....	4-12
4.19	Special Procedure: Short Field Take-off.....	4-12
4.20	Special Procedure: Slow Speed Sink and Recovery.....	4-12
4.21	Training Engine In-flight Shut-down and Air Restart.....	4-13
4.22	Noise Abatement.....	4-13



INTENTIONALLY LEFT BLANK

## SECTION 4 - NORMAL PROCEDURES

This section contains check list items, instructions and procedures for the operation of the gyroplane. However, these procedures do not replace the pilot's appreciation of the individual situation.

### 4.1 Airspeeds for Safe Operation

Climb .....	100 - 110 km/h IAS
Best rate of climb / best endurance .....	90 - 100 km/h IAS
Best range .....	120 km/h IAS
Approach .....	100 km/h IAS

### 4.2 Preparation for Flight

The pilot shall be familiar with the aircraft limitations detailed in SECTION 2 of this manual and shall have performed proper flight planning considering required legal aspects, as well as SECTION 5 'PERFORMANCE' and SECTION 6 'WEIGHT AND BALANCE' of this manual. The use of check lists as provided in this manual is mandatory for a safe operation.

### 4.3 Daily or Pre-flight Checks

All daily or pre-flight check list items consist of visual checks and do not replace professional mechanical inspection and maintenance. The following check list applies for the standard MTOsport gyroplane.

Note that depending on optional equipment installed the necessary checks may include additional items according to the flight manual supplement provided with the optional equipment. It is advisable for the owner/operator to compile his own check list suitable to his particular configuration.

The pre-flight check is structured into 11 stations which are organized as a clock-wise walk-around to provide a logical flow and sequential order, thus minimizing the risk of left-over or overlooked items. Start and end station are chosen so that a possible replenishing of oil will not unnecessarily interrupt the flow of checks.

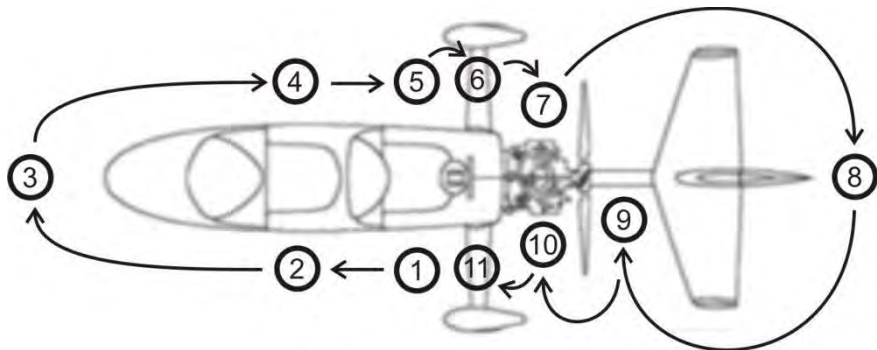

The following checks must be carried out before each flight. However, if the gyroplane is operated by a single pilot or within an organization where the checks are performed by or under the supervision of qualified personnel, check list items marked with a preceding 'O' may be carried out daily, before the first flight of the day.

**Before exterior check**

- Fuel tank drain(s)..... Sample
- Snow/ ice (if any)..... Removed
- Documents ..... Check complete

**Exterior check**

**Station 1** (passenger station, LH side)

*Behind passenger seat:*

- Before turning prop: MAG switches ..... Check OFF
- Engine oil level ..... Check
- Dipstick and oil cap..... Installed & Secure
- Battery and relay ..... Secure
- 12V Electrical terminals ..... Secure
- 12V Cabling and isolation ..... OK, no chafing
- Main frame and welded joints ..... No cracks, no deformation
- Flight control base link ..... All bolts secure
- Flight control base link hardware ..... No cracks, no deformation
- Lower flight control rod ends (2x).....No excessive play and secure

*Passenger station:*

- LH (main) fuel tank, level and cap..... OK
- Aft control stick ..... Removed
- Control linkage and support bearing ..... Check
- Static port.....Clean, undamaged

**Station 2** (pilot station, LH side)

- Rotor brake pressure.....min. 6 bar
- Throttle lever ..... Check function, full travel
- Brake lever and lock ..... Check function and condition
- Brake fluid level ..... Check
- Rudder control rods, LH..... Check

**Station 3 (nose)**

- General appearance ..... OK
- Windshield condition and cleanliness ..... Check
- Pitot cover (if installed) ..... Removed
- Rotor lash bag ..... Removed
- Storage compartment in nose section ..... Closed and locked
- ⊙ Nose wheel condition and air pressure ..... Check
- ⊙ Nose wheel control linkage ..... Check

**Station 4 (pilot station, RH side)**

- Forward control stick bolts and nuts ..... Secured
- Rudder control rods, RH ..... Check
- Loose objects ..... Removed/secured

**Station 5 (passenger station, RH side)**

*Behind passenger seat:*

- ⊙ Main frame and welded joints ..... No cracks, no deformation

*Passenger station:*

- ⊙ Aft seat ..... Latched
- Aft seat belts ..... Fastened and tight
- Rudder control cables ..... Free
- Rudder control cable tension ..... Check
- Tensioning devices ..... Hardware secure
- ⊙ Forward main frame ..... No cracks, no deformation
- RH (aux) fuel tank, level and cap ..... OK
- Loose objects ..... Removed/secured
- Static port ..... Clean, undamaged

**Station 6 (main gear spring spar, RH)**

- RH Main wheel running surface ..... Check
- Air pressure and slip mark ..... Visual check
- ⊙ Brake and wheel attachment ..... Check
- Wheel pant and attachment ..... Check
- ⊙ Main gear spring spar attachment ..... Check
- Main gear spring spar ..... No cracks
- Bell crank RH and control rod ends ..... No excessive play and secure
- Upper control rod end RH ..... No excessive play and secure
- Cardanic hinge bolts (2x) ..... Cotter pins installed
- ⊙ Main rotor bearing ..... Check condition
- ⊙ Pre-rotator assembly and brake ..... Check condition
- ⊙ Teeter bolt (bolt end) ..... Free to turn
- Teeter bolt (nut end) ..... Cotter pin installed
- ⊙ Teeter stops ..... Check
- ⊙ Rotor hub and blade clamping area ..... Check
- Blade attachment bolts ..... All installed and fastened
- ⊙ Inner blade caps ..... Tight

**Station 7** (engine, RH side)

- Main frame rear side / welded joints..... No cracks, no deformation
- Oil cooler and hoses RH..... Clean, no leaks, fittings tight
- Oil filter..... Tight
- Water cooler and hoses RH..... Clean, no leaks, fittings tight
- Exhaust system RH.....No cracks
- Engine oil and coolant hoses RH..... Check
- Ignition cables and spark plugs..... Check
- Air filter.....Clean and tight
- Coolant level..... Check
- Pre-rotator engine mounting bracket.....No cracks
- Pre-rotator coupling sleeves ..... Lubricated and easy to move
- Pre-rotator activation/articulation arm .....
- manually depress slightly.....check shaft turns easily
- release / neutral position..... check braking action
- Pre-rotator belt and pulleys..... Check condition
- Pre-rotator horizontal drive and flanges ..... No cracks or deformation
- Pre-rotator intermediate gear.....No leaks
- Pre-rotator vertical drive and flanges ..... No cracks or deformation

**Station 8** (stabilizer)

- Stabilizer general condition..... Check
- Stabilizer attachment..... Check
- Main frame aft end.....No excessive wear
- Rudder control cable linkage ..... Check
- Upper rudder bearing..... Secure, no excessive play
- Rotor blades condition and cleanliness..... Check
- Blade tips ..... Tight

**Station 9** (propeller)

- Propeller condition and cleanliness..... Check
- Propeller leading edge and tips..... No damage
- Propeller flange bolts..... Tight
- Variable pitch propeller (if installed): brushes..... Check
- Variable pitch propeller (if installed): tension strips ..... Check
- Rear main frame and welded joints..... No cracks, no deformation
- Rudder control cables..... Check

**Station 10** (engine, LH side)

- Main frame rear side / welded joints..... No cracks, no deformation
- Oil cooler and hoses LH ..... Clean, no leaks, fittings tight
- Water cooler and hoses LH ..... Clean, no leaks, fittings tight
- Exhaust system LH.....No cracks
- Engine oil and coolant hoses LH..... Check
- Ignition cables and spark plugs LH ..... Check
- Air filter.....Clean and tight
- Turbocharger / waste gate (R914) ..... Check condition and function



**Station 11** (main gear spring spar, LH)

- LH Main wheel running surface ..... Check
- Air pressure and slip mark ..... Visual check
- Brake and wheel attachment ..... Check
- Wheel pant and attachment ..... Check
- Main gear spring spar attachment ..... Check
- Main gear spring spar ..... No cracks
- Bell crank LH and control rod ends ..... No excessive play and secure
- Upper control rod end LH ..... No excessive play and secure
- Teeter bolt (bolt end) ..... Free to turn
- Teeter bolt (nut end) ..... Cotter pin installed
  
- Rotor lash bag ..... As required

**4.4 Before Boarding**

*Passenger station:*

- Fuel level and fuel caps ..... Check
- Pneumatic mode selector ..... Check BRAKE position
- Rotor brake pressure ..... Check/set min. 6 bar
- Rotor lash bag ..... Removed and stowed
- Passenger ..... Briefed and secure (helmet, hair, gear)
- Aft seat belts ..... Fastened and tight
- Loose objects ..... Removed / secured
- Fuel shut off valve (if installed) ..... Open and guarded

*Pilot station:*

- Loose objects ..... Removed / secured
- Document bag ..... Closed

**4.5 Before Starting Engine**

- Seat belts ..... Fastened
- Helmet(s) ..... Secure
- Flight suit(s) ..... All pockets closed
- Flight controls ..... Free
- Altimeter ..... Set to airfield elevation

## 4.6 Starting Engine

Parking brake ..... Set

*Cold engine:*

Throttle ..... Idle

Choke ..... Fully engaged

*Warm engine:*

Throttle ..... Idle or slightly cracked

Choke ..... disengaged

Master switch ..... ON

### All engine variants:

Note GEN indicator light ON

Note LOW VOLT flashing briefly

### ROTAX 914 engine:

Note BOOST WARN light and BOOST CAUTION light ON for about 2 seconds and buzz of electrical fuel pump.

Second fuel pump P2 (if installed) ..... ON

**All engine variants:** Note (increased) fuel pump buzz.

Variable pitch propeller (if installed) ..... FINE

ACL / Strobe (if installed) ..... ON

Both MAG switches ..... ON

Propeller and area ..... "Clear"

Starter (with right hand, left hand on throttle/brake) ..... Engage

Hold starter until engine fires, but for a maximum of 10 seconds. Generally the engine fires immediately. In case of an unsuccessful starting attempt check all preconditions. Wait at least 20 seconds to allow cooling of battery and starter motor before repeated activation.

Oil pressure ..... min. 1.5 bar

Second fuel pump P2 (if installed) ..... OFF

Avionics/Radio/Intercom ..... ON

Choke ..... slowly disengage

## WARNING

**Never attempt to start the engine until the area around the propeller is completely clear of any persons or objects. Do not start the engine while standing beside the aircraft as you will easily be struck by the propeller in case of a brake failure or an operating error.**

## 4.7 Taxi and Run-up

During taxi do not exceed 15 km/h which is approximately jogging speed and steer with careful pedal input. Use wheel brake carefully, if needed, but not before throttle lever has been completely pulled to idle. Control stick should always be maintained in forward centre position. When taxiing on uneven ground, use particular caution and hold control stick so as to avoid the blades or control system hitting their mechanical stops.

Carry out engine run-up in an area with least derogation to individuals and other airport ground traffic, preferably headed into the wind.

Warm-up RPM .....2000 – 2500 RPM  
Oil temperature and other engine indications ..... within limits

*At taxi holding position:*

Magneto check (at 4000 RPM).....max. 300 RPM drop  
with max. difference between magnetos ..... 115 RPM

Switch ignition/magnetos with right hand while left hand resides on  
throttle/brake.

Throttle ..... Idle  
Warning and caution indications .....None  
Instruments / altimeter .....Cross check  
NAV lights..... As required  
Second fuel pump P2 (if installed)..... ON  
Approach and runway ..... Clear, then line-up

## 4.8 Take-off Procedure

- Check relative wind
- Maintain control stick in forward position with right hand
- Switch pneumatic mode selector to FLIGHT and return to brake with left hand
- Hold wheel brake without having locking pawl engaged
- Release trim pressure by trimming full forward
- While holding wheel brake adjust 2000 RPM with throttle
- Activate and hold pre-rotator
- Let pneumatic clutch fully engage (stabilization at about 100 rotor RPM).  
If necessary release pre-rotator button momentarily and press again to maintain engine RPM within green arc, respectively prevent engine from stalling
- Carefully increase throttle (~ 150 R-RPM/sec) to 200 R-RPM – max. 240 R-RPM
- Release pre-rotator button
- Gently move the control stick fully aft (stick travel ~ 1 second)
- Release wheel brake with throttle unchanged
- Monitor rotor speed and adequately increase throttle to take-off power

**WARNING**

Before activating the pre-rotator, check area is clear and consider the risk that passenger's hair or loose garment can be caught in the pre-rotator drive shaft.

**WARNING**

Prior to releasing the wheel brake make sure that the control stick is fully aft. A take-off run with flat rotor system may have fatal consequences.

**WARNING**

With the rotor speed below green arc relative speed must be built-up carefully to allow rotor speed to increase first. If the situation cannot be corrected, abort take-off run.

**CAUTION**

Do not engage pre-rotator at too high engine RPM or until too high rotor RPM as this will lead to pre-rotator drive damage.

**NOTE**

Perform take-off into the wind and with least possible crosswind component.

**NOTE**

To avoid unintended engagement in flight the pre-rotator can only be activated with the control stick in its most forward position.

#### 4.9 Take-off Run

- Check min. 5400 RPM for take-off. Otherwise, abort take-off
- Minimize lateral drift by applying appropriate lateral control stick input into cross wind direction
- Maintain directional control i.e. runway alignment with sensitive pedal input
- When nose comes up allow nose wheel to float at about 10 – 15 cm above the runway by a balanced reduction of control stick back pressure
- Maintain attitude until speed increases and gyroplane lifts off
- Allow gyroplane to build-up speed in ground effect

**VPP:** With a variable pitch propeller installed, refer to the respective flight manual supplement in CHAPTER 9 for correct power setting and handling procedure.

#### WARNING

**Gyroplanes are fully controllable at very low speeds without exhibiting any signs of wing stall or soft flight controls, as it would be perceived in a fixed wing aircraft. However, operation 'behind the power curve' may have fatal consequences during take-off, initial climb or in any other situation within ground proximity. Always allow aircraft to build-up safe climb speed before allowing it to gain height.**

#### 4.10 Climb

- Perform initial climb at safe climb speed and adjust trim
- Set power to maximum take-off power
- Check engine instruments and respect maximum take-off power time limit
- Switch off second fuel pump at safe height
- At safe altitude, the climb may be continued with  $V_Y$  and reduced power setting for noise abatement
- When desired altitude is approached, level gyroplane and reduce power

**VPP:** With a variable pitch propeller installed, refer to the respective flight manual supplement in CHAPTER 9 for correct power setting and handling procedure.

#### 4.11 Cruise

- Adjust power setting within the maximum continuous power range
- Adjust trim

**VPP:** With a variable pitch propeller installed, refer to the respective flight manual supplement in CHAPTER 9 for correct power setting and handling procedure.

#### 4.12 Descent

- Reduce power setting and lower nose
- Adjust trim

**VPP:** With a variable pitch propeller installed, refer to the respective flight manual supplement in CHAPTER 9 for correct power setting and handling procedure.

#### 4.13 Approach

- Switch ON second fuel pump P2 (if installed)
- Set variable pitch propeller (if installed) to FINE
- Check all warning and caution indications OFF
- Check all instruments in normal operating range
- Check wheel brake unlocked
- Maintain and trim approach speed
- Control glide angle with engine power

#### WARNING

**With low fuel level an excessive nose-down attitude, for example in a steep descent, can lead to premature fuel starvation. An approach within the gliding distance to the airport or landing site is generally considered to be the safest option.**

#### 4.14 Landing

- Align gyroplane with rudder and correct drift with lateral control input, even if this results in a side slip indication
- Maintain approach speed until approximately 5m above runway
- Initiate round out to reduce sink rate and let ground approach
- Perform final flare close to ground as speed will decay rapidly
- Let gyroplane settle on main gear with nose wheel slightly above the ground
- Hold nose wheel closely above ground and let it sit down with pedals neutral at the lowest possible ground speed
- Maintain aft control stick to reduce speed until walking speed. Wheel brake may be used to assist, if needed

#### CAUTION

**When landing in a strong headwind do not use wheel brake to prevent gyroplane from rollback. In order to compensate for any rollback tendency, flatten rotor disc as required and increase propeller thrust, if necessary.**

#### 4.15 Go-around

- Apply take-off power. Counteract yaw tendency and align gyroplane with rudder input.
- In horizontal flight, allow gyroplane to gain speed
- Climb with safe or best rate of climb speed and adjust trim

**VPP:** With a variable pitch propeller installed, refer to the respective flight manual supplement in CHAPTER 9 for correct power setting and handling procedure.

#### 4.16 After Landing

- Control stick full forward to level-off rotor disc, at latest when rotor speed leaves green arc! Be prepared for reduced rotor drag!
- Use lateral control into wind to maintain rotor disc in level attitude. Adjust lateral control input as rotor speed decays
- Bring pneumatic mode selector to BRAKE position and return to wheel brake with left hand
- Apply rotor brake pressure by using AFT TRIM. Monitor pressure gauge
- Taxi carefully, preferably not above walking speed and mind high centre of gravity when taking turns
- Do not vacate gyroplane until engine and rotor is at a complete stop

#### WARNING

**Mind the spinning rotor and propeller when taxiing close to obstructions or persons. A fast turning rotor is almost invisible, but may contain enough energy to kill a person.**

#### CAUTION

**There are different riskless techniques to park the blades fore and aft. Abrupt pedal input during taxi should be avoided.**

#### NOTE

**It is advisable to let the rotor spin down while the gyroplane is at a complete stop. However, in order to vacate the runway, it is possible to taxi while the rotor is spinning down. In this case, be aware of the effects of relative wind on advancing and retreating blade, compensate with lateral control input, and adjust taxi speed carefully as to avoid blade flapping.**

#### 4.17 Engine Shut-down

Throttle .....	Idle
Parking brake .....	Set
Turbo charger cool-down (ROTAX 914 engine) .....	min. 30 seconds
Second fuel pump (if installed) .....	OFF
Avionics/Radio/Intercom/Lights (except ACL / Strobe) .....	OFF
Both MAG switches .....	OFF
ACL / Strobe (if installed) .....	OFF
Master switch .....	OFF and key removed

#### 4.18 Parking

- Install rotor lash bag
- Secure gyroplane against rolling using parking brake and chocks, if parked on a slope
- Double check to have master switched OFF and keys removed
- Install protection cover if available or appropriate

#### NOTE

**Avoid long term parking of the aircraft with empty tanks. This will increase the risk of water accumulation in the tanks and will lead to shrinking of the rubber tap seal.**

#### 4.19 Special Procedure: Short Field Take-off

A short field take off is conducted in exactly the same manner as a normal take-off, but performed with maximum precision. Therefore, a short field take-off is not so much a procedural thing, but needs practice, experience and mentoring. Apart from environmental aspects such as wind and density altitude, the condition of the gyroplane and its gross weight, the key factors for a short take-off performance are:

- Maximum allowed pre-rotation RPM and no time lost until stick is fully aft (if headwind component allows) and brake is released
- Maximum take-off power is set immediately while stick remains fully aft until nose wheel rises
- Nose wheel held tight above surface and minimum side drift until lift-off
- No over controlling that would result in the nose swinging up and down
- $V_Y$  climb with no side slip

#### 4.20 Special Procedure: Slow Speed Sink and Recovery

- Reduce power to idle and let speed decrease by gently using aft control stick
- Maintain enough forward speed for sufficient rudder effectivity
- Rudder will regain effectivity quickly as soon as airspeed or propeller thrust is increased
- To recover, let nose drop slightly below the horizon and build-up air speed while adding power at the same time



### 4.21 Training Engine In-flight Shut-down and Air Restart

The engine should not be stopped in flight deliberately except as part of forced landing training under the supervision of a qualified flight instructor. If possible, allow the engine to cool down at 3000 rpm for about 30 sec before turning it off.

Make sure both magnetos are switched back ON and the master switch/starter key has been turned to OFF and back to ON to be prepared for an immediate engine start-up in case the manoeuvre has to be aborted.

#### NOTE

**Be aware of reduced rudder effectivity with standing propeller. Be prepared to use larger pedal input and more left pedal than usual to keep gyroplane aligned.**

After a restart, allow engine and oil to warm-up, if possible, before full power is applied.

### 4.22 Noise Abatement

A positive attitude towards residents and environmental-friendly flying supports the reputation and acceptance of aviation in general, and gyroplanes in particular. When compared to other airplanes the noise of a gyroplane is sometimes perceived as unpleasant although it meets the same or sometimes more stringent noise emission requirements. This effect can be attributed to the pusher concept where the propeller is exposed to air flow which was distorted by the fuselage. The degree of distortion, and therefore the noise emission of the propeller, is significantly lower at reduced speeds. The best practices to keep noise level low and general acceptance high are:

- Climb with the speed for best rate of climb  $V_Y$  as soon as altitude permits
- Especially in climb keep side slip to a minimum to establish a clean configuration. In addition, this guarantees the best climb performance
- For your own safety always maintain safe altitude and avoid unnecessary 'low-flying'
- When overflying populated areas, look ahead and select the least noise sensitive route
- Repetitive noise is far more irritating than a single occurrence. If you must fly over the same area more than once, vary your flight path
- Avoid blade slap. Blade slap can occur as a result of inadequate piloting technique or during aggressive manoeuvres, but will not appear in normal flight regime

#### NOTE

**Above procedures do not apply where they would conflict with Air Traffic Control, within the traffic pattern, or when, according to pilot's judgement, they would result in an unsafe flight path.**



INTENTIONALLY LEFT BLANK

## CONTENTS

5.1	Demonstrated Operating Temperature .....	5-1
5.2	Airspeed Calibration .....	5-1
5.3	Height-Velocity Diagram .....	5-2
5.4	Speeds .....	5-3
5.5	Rate of Climb.....	5-3
5.6	Take-off and Landing Data .....	5-3
5.7	Influence on Take-off Distance and Climb Rate .....	5-4
5.8	Glide Ratio .....	5-5
5.9	Additional Performance Data .....	5-6
5.9.1	Fuel Flow.....	5-6
5.9.2	Service Ceiling.....	5-6
5.10	Sound Exposure Level / Noise Characteristics .....	5-6

INTENTIONALLY LEFT BLANK

## SECTION 5 - PERFORMANCE

The following data were determined by flight testing and demonstrated with average piloting skills, with engine and aircraft in good condition, as well as clean main rotor and propeller. The parameters apply to standard conditions (15 °C at sea level and standard pressure) and a gross mass of 450 kg. Note that a higher airfield elevation, increased temperature and/or low air pressure will have a negative effect on performance.

### 5.1 Demonstrated Operating Temperature

Satisfactory engine cooling has been demonstrated to an outside air temperature of 40 °C.

### 5.2 Airspeed Calibration

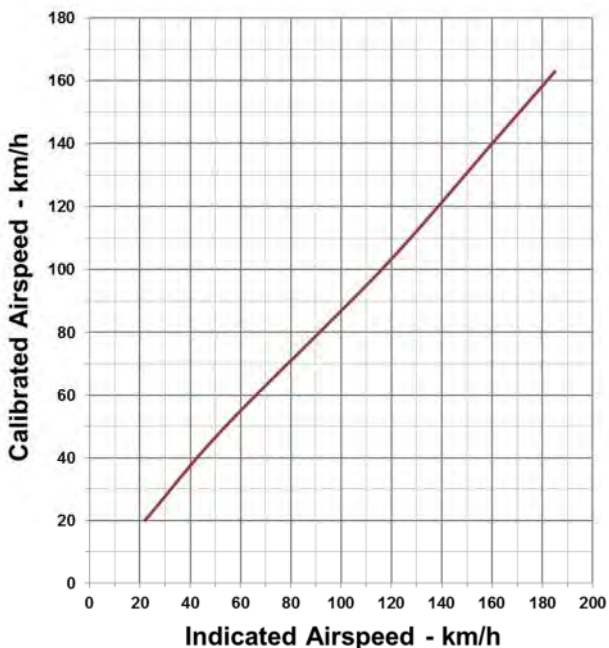

**Example:** Indicated airspeed of 140 km/h represents a calibrated airspeed (corrected for installation error) of 121 km/h.

### 5.3 Height-Velocity Diagram

The H/V diagram indicates combinations of height and speed (avoid area left side of the red graph) where a safe landing may not be possible in case of an engine failure. Therefore, operation on the left side of the red line must be avoided.

Take-offs and landings should be conducted according to the recommended flight profile, provided as blue dashed line.

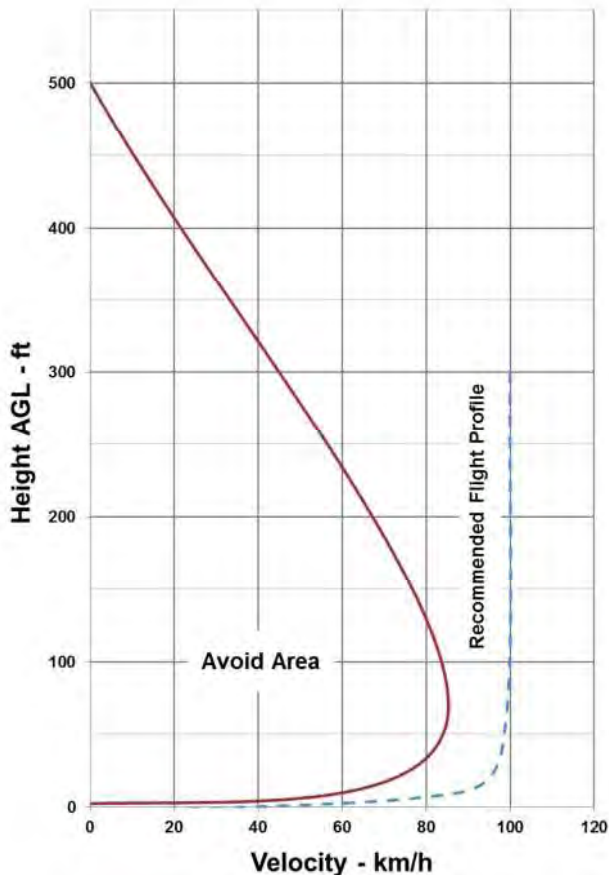

## 5.4 Speeds

The following speeds are relevant for flight performance. For additional speed limitations refer to SECTION 2 LIMITATIONS of this manual.

Minimum horizontal speed, TOP (only ROTAX 914) .....	30 km/h IAS
Minimum horizontal speed, TOP .....	35 km/h IAS
Minimum horizontal speed, MCP .....	40 km/h IAS
Speed for best angle of climb $V_X$ .....	75 km/h IAS
Speed for best rate of climb or maximum endurance $V_Y$ .....	90 km/h IAS
Best range speed .....	120 km/h IAS
Long range speed* .....	140 km/h IAS

\* Long range speed is the speed faster than the best range speed which results in a slightly lesser range but represents a good compromise between range and saved air time.

## 5.5 Rate of Climb

Rate of climb, 450 kg, $V_Y$ , MCP .....	4 m/s
Rate of climb, 360 kg, $V_Y$ , MCP .....	6 m/s

## 5.6 Take-off and Landing Data

Take-offs and landings have been demonstrated up to a crosswind component of 36 km/h.

The following data is valid for operation at a gross mass of 450 kg at an even air strip with short grass, no wind, and pre-rotation to 220 RPM. Take-off and landing distances account for a 15m obstacle.

Take-off roll* .....	80 – 120 m
Take-off distance* .....	300 m

\* Take-off roll and take-off distance will be shorter using the boost regime of the ROTAX 914 engine

Landing roll .....	0 – 20 m
Landing distance .....	150 m

### 5.7 Influence on Take-off Distance and Climb Rate

All flight performance figures presented in this chapter are based on standard atmospheric conditions in sea level. Depending on actual temperature and pressure altitude (elevation) factors on take-off distance and climb rate can be deduced from the following chart.

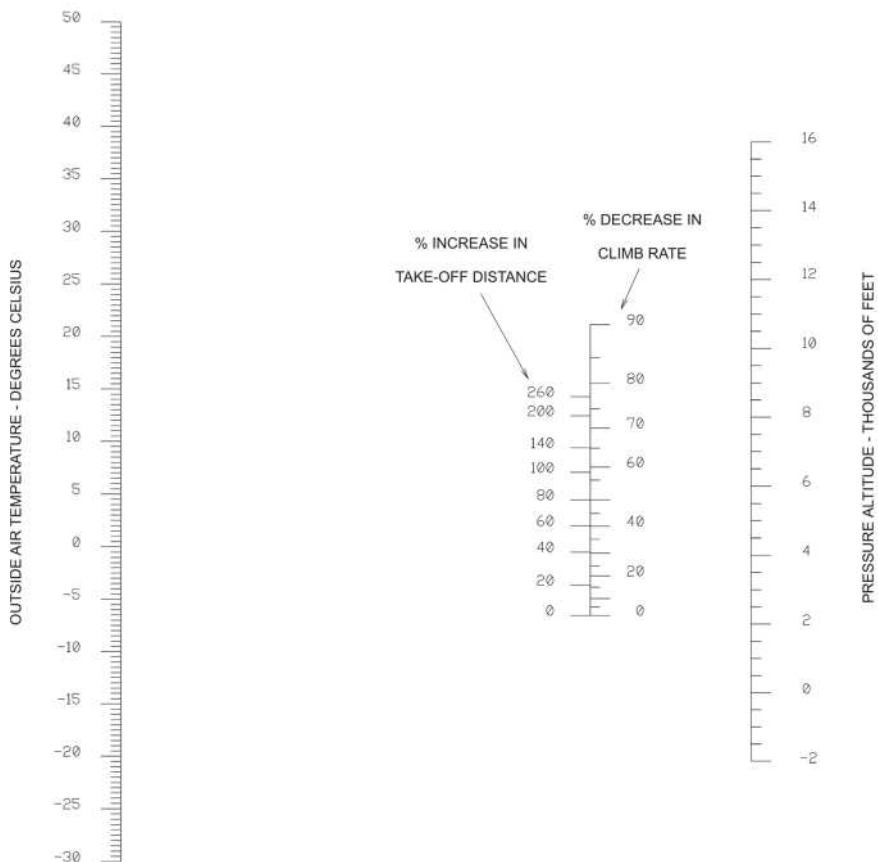

See next page for example.



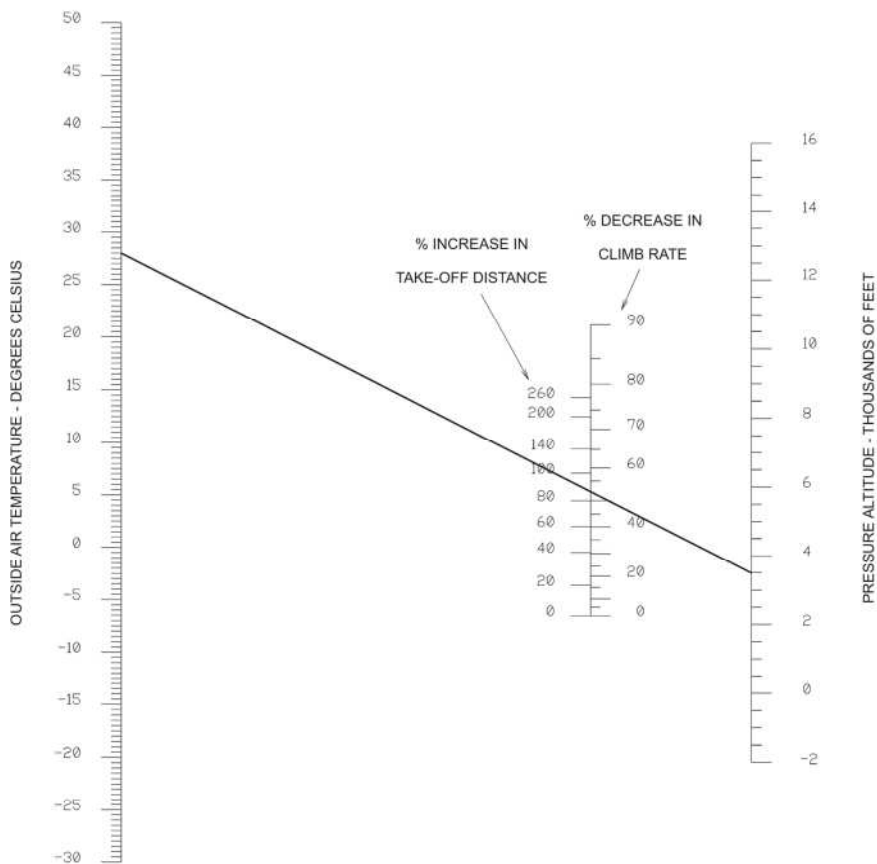

**Example:**

Given: Outside Air Temperature 28 °C and Pressure Altitude 3500 ft  
 Result: 88 % increase in take-off distance and climb rate reduced by 53 %

## 5.8 Sink Rate and Glide Ratio

The sink rate depending on airspeed with the engine in idle is plotted in the following diagram:

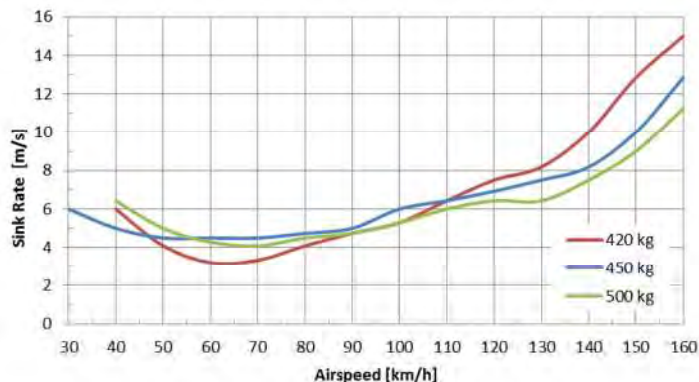

In case of an engine failure, expect a glide ratio of 1:3 which corresponds to a vertical distance of 900 m or 0.5 nautical miles for each 1000 ft.

## 5.9 Additional Performance Data

### 5.9.1 Fuel Flow

The following fuel flow figures are provided as estimates and do not constitute certified performance. Exact fuel flow will vary with environmental conditions, cleanliness of propeller and rotor, piloting technique (minimum side slip), and power setting. For additional procedures about proper power setting consult SECTION 9 for supplemental data concerning the variable pitch propeller, if installed.

Fuel flow at 120 km/h IAS.....	15 ltr/h
Fuel flow at 140 km/h IAS.....	18 ltr/h

### 5.9.2 Service Ceiling

The service ceiling is based on 450 kg take-off weight, maximum continuous power, and a residual climb gradient of 0.5 m/s.

ROTAX 912 ULS.....	10000 ft
ROTAX 914 UL.....	13000 ft

## 5.10 Sound Exposure Level / Noise Characteristics

The noise certificate was granted according to the German requirements for noise protection for microlight gyroplanes ("Lärmschutzverordnung für Ultraleichte Tragschrauber") stating an overfly noise of 68 dB or less.



## CONTENTS

6.1	General .....	6-1
6.2	Weight and Balance Record .....	6-1
6.3	Compliance with Weight and Balance.....	6-1



INTENTIONALLY LEFT BLANK

## SECTION 6 - WEIGHT AND BALANCE

### 6.1 General

The gyroplane must be operated within the weight and balance limits as specified in SECTION 2 of this manual. Loading situations outside these limits can result in restricted flight control and can ultimately lead to degraded safety.

### 6.2 Weight and Balance Record

An initial weighing report and equipment list showing gyroplane configuration, empty weight and centre of gravity is delivered with each gyroplane. This data applies to the gyroplane as delivered from the factory. Any changes in the configuration should be performed by a qualified maintenance station and documented. After modifications and at regular intervals a new weighing report and equipment list should be issued.

### 6.3 Compliance with Weight and Balance

The MTOsport gyroplane is designed in such way that compliance with weight and balance is provided, if

- the gyroplane is loaded within the individual weight limitations for each station as provided in SECTION 2 of this manual, and
- the certified maximum take-off weight, representing the total sum of pilot, passenger, baggage, fuel and current empty weight is not exceeded



INTENTIONALLY LEFT BLANK

## CONTENTS

7.1	Introduction.....	7-1
7.2	Airframe and Undercarriage.....	7-1
7.3	Doors, Windows and Exits.....	7-1
7.4	Fuel System .....	7-1
7.5	Pneumatic System.....	7-3
7.6	Power Plant.....	7-4
7.7	Propeller.....	7-4
7.8	Rotor System.....	7-5
7.9	Flight Controls .....	7-5
7.10	Electrical System .....	7-7
7.11	Lighting System .....	7-7
7.12	Instrument Panel .....	7-8
7.13	Intercom .....	7-13
7.14	Pitot Static .....	7-13
7.15	Indicators and Sensors.....	7-13
7.16	Seats and Seatbelts .....	7-13
7.17	Stowage Capacity.....	7-13

INTENTIONALLY LEFT BLANK



## SECTION 7 - SYSTEM DESCRIPTION

### 7.1 Introduction

This section contains the description of the gyroplane and its standard systems and equipment. Optional equipment is described in Chapter 9 of this manual.

### 7.2 Airframe and Undercarriage

The load carrying structure of the gyroplane consists of an inert-gas welded stainless steel square tube framework and includes mast, forward extension, and aft extension. The main frame carries all loads induced by the crew stations, engine, rotor, undercarriage, stabilizer, and serves as installation platform for additional equipment.

The fuselage belly including its two crew stations is made of glass fibre reinforced plastic. It is mounted to the forward extension of the main frame and is not designed as a load carrying structure.

Stabilizer structure with rudder is made of GRP (or in certain cases CRP) and is bolted to the aft extension of the main frame. Attachment points for the engine installation are provided by a steel tube ring mount at the rear of the mast, which also supports the rotor at its top end.

The landing gear consists of a steerable nose wheel in a steel fork and two main wheels with hydraulic brake system. Both main wheels are equipped with wheel pants made from GRP and are mounted to the ends of the spring spar, which is made from GRP. The spar is designed to absorb even higher than normal landing loads in case of a hard landing or crash. The spring spar is bolted to a support frame at the bottom of the mast and main frame.

### 7.3 Doors, Windows and Exits

This gyroplane is designed as an open cockpit aircraft and features no doors. Two windshields from break-proof polycarbonate protect the crew against the air stream, insects, and direct rain. Access and exit is provided over the sillboard on the right hand side.

### 7.4 Fuel System

The fuel tanks are located under the rear seat and have a capacity of 34 litres each. In standard version only one tank is installed on the left hand side. As an option an additional tank with the same capacity may be fitted on the right hand side. The tanks are made from PE plastic and feature a ventilation line that is routed above the tank to the rear of the mast. A drain valve is available in the bottom aft area of each tank that accepts a standard drain tool with pin to open the valve.

In case of two fuel tanks installed, a crossover line connects both to ensure equal level. In order to top-off tanks it is recommended to fill both tanks sequentially as the cross-over flow rate is limited. Fuel hoses are made of fabric-reinforced rubber.

Markings at the front side of the fuel tanks show fuel quantity in level attitude, using a scale and numerical values for every 5/10 litres. The marking shows fuel tank quantity per tank. If a second fuel tank is installed, the total fuel quantity is the sum of both readings.

As an option, a fuel quantity indication in the cockpit, as well as low fuel sensors may be installed. The LOW FUEL warning light is triggered as soon as 5 litres or less of useable fuel remain in the tanks.

The fuel system versions differ with engine model, see schematics below.

**Fuel system engine version ROTAX 912 ULS:**

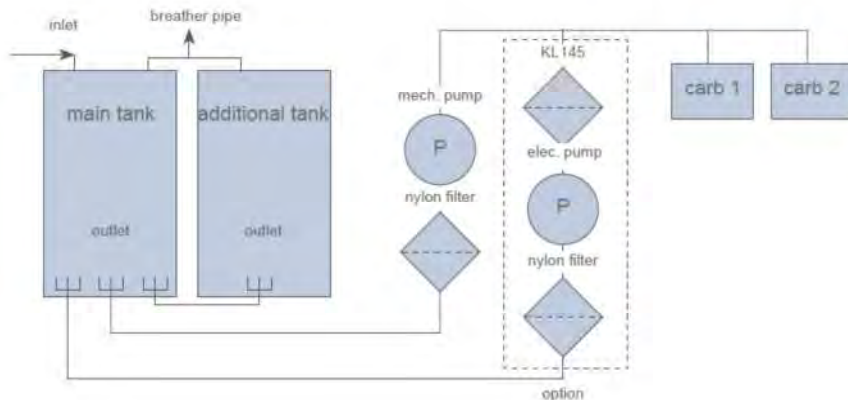

**Fuel system engine version ROTAX 914 UL:**

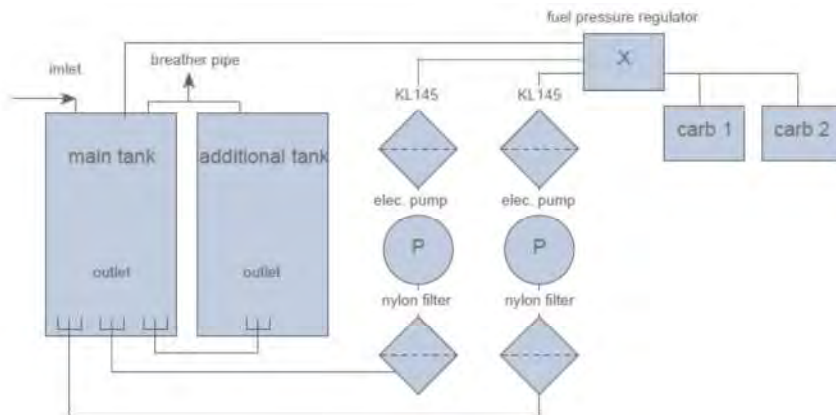

## 7.5 Pneumatic System

Aircraft trim, rotor brake and activation of the pre-rotator is controlled by a pneumatic system, consisting of an electrically driven air compressor with dry cartridge, a pressure gauge in the cockpit, solenoid valves, air lines, pneumatic actuators, and the respective cockpit controls.

### Trim function

Trimming is effected by varying trim pressure in the pneumatic trim actuator which is installed in parallel with the rotor head tilt for pitch control. Aft or nose-up trimming activates the electrical compressor and increases trim pressure, causing the actuator to retract, and tilting the rotor disc aft. Forward trimming opens the pressure relief valve to reduce trim pressure and allows the rotor disc to flatten, due to the spindle head offset and the gyroplane's weight. The actual trim condition is indicated on the trim/brake pressure gauge in the centre panel of the cockpit.

### Rotor brake

With the pneumatic mode selector in BRAKE position the operation of the pneumatic trim actuator is reversed so that increased pressure causes the actuator to push the rotor head up (or level) and presses a brake pad against the rotor head disc. In order to increase brake pressure, move the 4-way trim switch to aft. Note that this action will also push the control stick forward. At full brake pressure the control stick will be maintained in its full forward position.

### Activation of the pre-rotator

The pre-rotator is activated as long as the respective switch on the control stick head is depressed, provided the following pre-conditions are met:

- pneumatic mode selector set to FLIGHT
- control stick in full forward position, controlled by a micro switch installed in the control linkage at the bottom of the pilot's control stick
- trim pressure less than 3 bar

When activated the pneumatic actuator at the pre-rotator belt clutch is pressurized, lifting the smaller pulley out of its brake position and tensioning the belt at the same time. Engine torque is then transmitted through the lower pre-rotator drive, a 90° gearbox and upper drive to the pinion which is engaged by another small pneumatic actuator into the geared ring of the rotor head. The drive pinion is sliding on a helical gear to provide automatic lock-out in case of rotor RPM overrun. In order to allow necessary changes in length both pre-rotator drive shafts feature a sliding sleeve coupling.

### Activation of the pre-rotator in BRAKE position

The pre-rotator can be activated in BRAKE position to park the rotor blades fore-aft for taxi. To do so, the pre-rotator switch and the overdrive/override switch in the cockpit panel have to be pressed simultaneously. Avoid prolonged activation of the pre-rotator with rotor brake engaged.

## 7.6 Power Plant

### Engine

There are two engine variants available, being the ROTAX 912 ULS normally aspirated reciprocating engine and the ROTAX 914 UL turbo charged version. Both engine types are 4 cylinder, horizontally opposed, 4 stroke engines featuring

- Liquid cooled cylinder heads
- Ram air cooled cylinders
- Dry sump forced lubrication
- Dual breakerless capacitor discharge ignition
- 2 constant depression carburettors
- Hydraulic tappets
- Electric starter
- Generator (Alternator)
- Reduction gearbox with integrated shock absorber and overload clutch

The ROTAX 912 ULS engine provides a maximum take-off power of 100 horse power while the turbo charged version offers a maximum take-off power of 115 horse power. For technical details refer to the engine manufacturer's manual.

### Oil system

The oil reservoir with dipstick is behind the aft seat on the right hand side. Access to the reservoir is provided by unlatching the aft seat and folding it forward. The type of lubrication system requires a special procedure for accurate oil level checking and to prevent overfilling, which is described in SECTION 8 of this manual.

### Engine cooling

Engine cooling is provided by ram air cooled cylinders and liquid cooled cylinder heads. Therefore, cylinder head temperature (CHT) indication in the cockpit corresponds to water temperature. The water cooling system comprises engine driven pump, radiator(s), expansion tank with radiator cap, overflow bottle, and hoses.

The radiator is mounted at the lower aft end of the engine, just before the propeller. As an option a second radiator can be installed. In this case both radiators are installed left and right hand below the engine's main attachment behind air scoops.

For the relevant checking and replenishing procedures, refer to SECTION 8 of this manual and also the engine manufacturer's manual.

## 7.7 Propeller

A three-bladed, fixed pitch propeller with aluminium hub is used as standard version. The propeller blades are made from composite material with a foam core. As an option a variable pitch propeller is available which is described in SECTION 9 of this manual.

## 7.8 Rotor System

The two-bladed, semi-rigid, teetering rotor system comprises high-strength aluminium extruded rotor blades, a hub bar, and a common teeter hinge assembly.

The rotor blades feature an aerodynamic profile especially suitable for rotorcraft which, in combination with its relative centre of gravity, provides aerodynamic stability by eliminating negative blade pitching moments and flutter tendency. The hollow blade profile is sealed at both ends by plastic blade caps.

The aluminium rotor hub bar is pre-coned to the natural coning angle of the blades and connects the blades firmly to each side using 6 fitting bolts (9 bolts in earlier hub bars) and a clamping profile. In order to compensate for asymmetric air flow in forward flight the blades are free to teeter. The hinge assembly consists of teeter tower, teeter bolt and teeter block.

The teeter bolt runs in a long Teflon coated bushing in the teeter block (main bearing action), as well as two shorter bushings in the teeter tower (emergency bearing action). The main bearing action is supported by special grease which is applied through a grease nipple on top of the teeter block. Servicing is described in SECTION 8 of this manual.

## 7.9 Flight Controls

### Rotor head and trim control

Pitch and roll of the gyroplane are controlled by tilting the complete rotor head by means of the control stick. Control input is transferred via torsion tube and linkage running below the seats to the base link and from there to the rotor head via two split control rods with ball ends.

The control stick head is ergonomically shaped to fit the pilot's right hand and features control buttons for radio transmission (1), a four-way trim function (2), and activation of the pre-rotator (3).

The trim control works as a classical 4-way beep switch. Pulling the beep switch back increases aft trim or nose-up tendency, while pushing the switch forward reduces back trim pressure, leading to a nose-down tendency. Lateral trim input is not active on MTOsport models.

Because of a safety circuit, activation of the pre-rotator is only possible with the pneumatic mode selector in FLIGHT position and the control stick fully forward. This prevents inadvertent activation of the pre-rotator during flight or in BRAKE mode.

The aft stick is held by means of 2 bolts, self-locking nuts and a pair of distance washers within a bracket and must be removed unless the seat is occupied by a qualified flight instructor.



### Rudder and front wheel control

The Rudder is connected to the foot pedals with steel cables which are routed horizontally along the main frame. Both pairs of pedals are interconnected by a linkage. The nose wheel steering is directly linked to pedal/rudder control input by control rods.

### Throttle and brake quadrant

The throttle and brake quadrant with choke is located on the left side of the pilot station. Throttle control (1) is conventional with IDLE in aft (or pulled) and full throttle in most forward position. With the ROTAX 914 UL engine the boost range is entered by overcoming a small resistance to the front. The throttle lever is linked with cable controls to the carburetors. A mechanical spring applies tension to the control cables and brings the carburetors to full throttle in case of a cable break. The throttle lever has a pre-set friction brake which holds the throttle in the selected position.

Choke (3) is used start a cold engine. In order to do so, pull the choke lever fully to the rear or ON position (into the round indentation of throttle control lever) and be sure to have the throttle in idle position. After starting the engine and a short warm-up, the choke can be slowly disengaged by moving the lever into its forward or OFF position. Hold the throttle control firmly while pushing the choke to OFF as mechanical friction might move the throttle lever out of its idle position.

The hydraulic wheel brake is actuated by pulling the brake lever (2). A locking pawl mechanism allows setting for use as parking brake. In order to release the parking brake pull the brake lever a little further to let the spring-loaded locking pawl disengage, and then release wheel brake.

Do not try to disengage the locking pawl by pressing the small release lever without pulling the brake lever at the same time. Releasing the pawl using the small release lever only will lead to premature deterioration of the teeth. If the teeth are worn the function of the parking brake will be compromised!

The throttle and brake quadrant also supports the brake fluid reservoir (4) with screw cap and fluid level minimum and maximum markings, as well as the primary brake cylinder (5).

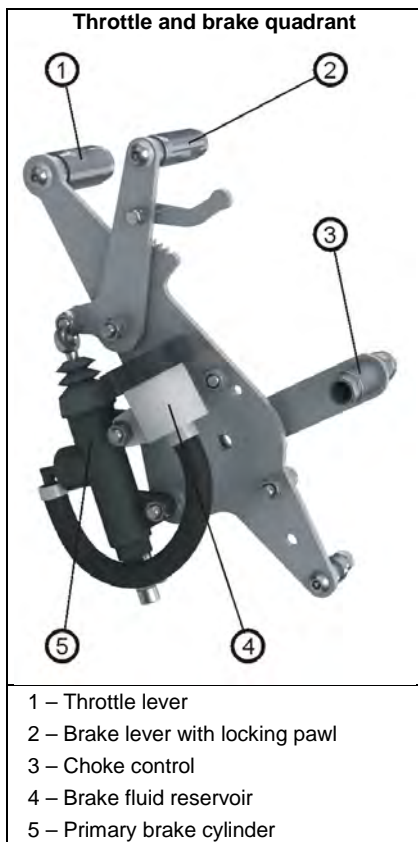

## 7.10 Electrical System

The 12V DC electrical system consists of an engine driven electrical generator, a battery, master switch, indicators, switches, electrical consumers, and cabling. With the ROTAX 914 UL engine an electrical power supply is vital for continued engine operation as this engine variant solely relies on electrically driven fuel pumps.

Turning the master switch to the ON position closes the battery contact and energizes the gyroplane's electrical system. The red LOW VOLT warning light will illuminate briefly as a functional check. A steady indication, however, warns the pilot that the voltage of the system has dropped below a safe value. A red GEN warning light is installed to indicate that the battery is not being charged.

The power consumption of individual equipment is listed in the following table:

<b>Equipment / System</b>	<b>Power load</b>
<i>Generator</i>	<i>(-) 240 W</i>
Electrical fuel pump	21 W
Pneumatic compressor	124 W (peak) / 103 W
NAV lights (standard)	108 W
NAV lights (LED)	9 W
Strobe lights	83 W
Landing light (standard)	100 W
Landing light (LED)	7 W
Radio ATR500	2 W (rcv) / 35 W (xmt)
Radio ATR833	7 W (rcv) / 35 W (xmt)
ATC Transponder TRT800H	max. 10 W
Garmin 695	40 W
Flymap F7 / Sky-Map T7	5 W
Flymap L	35 W
Flymap LD (dual screen)	70 W

## 7.11 Lighting System

The aircraft is approved for day VFR operation only. Position lights, landing light and strobes are available as optional equipment. If installed, refer to SECTION 9 of this manual.

## 7.12 Instrument Panel

Different instrument panel layouts are available. The basic instrumentation arrangements include:

- Standard Layout
- Moving Map Landscape
- Moving Map Portrait
- Glass Cockpit

The standard layout includes all instruments necessary for flight but also installation provisions for additional conventional instrumentation.

The panel layouts Moving Map Landscape or Portrait include all relevant instruments arranged in a way to accept most off-the-shelf moving map navigation devices in the respective format. For detailed user information and instructions concerning the different moving map systems please refer to the manufacturer's documentation.

### NOTE

**Any moving map system shall be used for reference only and does not replace proper flight planning and constant oversight and awareness.**

The Glass Cockpit layout is tailored to the integrated flight and navigation suite FlyMap LD. In addition to navigational and moving map functions, the system provides primary flight data and engine/vehicle monitoring. It is of utmost importance to read and understand the operators manual and to become familiar with the system before operation. In case of a system failure, a 2 ¼" (47mm) altimeter and air speed indicator is provided as back-up instrumentation.

Depending on the chosen instrumentation and optional equipment, the depicted panels on the following pages may vary.



Panel Layout - Standard



- |   |   |
|---|---|
| 1 – Engine RPM                                | 14 – Radio (if installed)                             |
| 2 – Pneumatic mode selector                   | 15 – Manifold pressure gauge (if inst.)               |
| 3 – Rotor RPM                                 | 16 – ATC transponder (if installed)                   |
| 4 – Altimeter                                 | 17 – GEN and LOW VOLT warning lights                  |
| 5 – Compass (2 ¼" cut-out)                    | 18 – Hour meter                                       |
| 6 – Air speed indicator                       | 19 – Low fuel warning light (if installed)            |
| 7 – Cut-out 3 1/8" for optional installations | 20 – BOOST Warn/Caution light (R914)                  |
| 8 – Oil pressure                              | 21 – MAG switches                                     |
| 9 – Oil temperature                           | 22 – Master/starter switch                            |
| 10 – Cylinder head temperature                | 23 – Trim/brake pressure gauge                        |
| 11 – 12V power receptacle (if installed)      | 24 – Rotor bearing temperature indication             |
| 12 – Overdrive push button                    | 25 – Switches (2 <sup>nd</sup> fuel pump and options) |
| 13 – ELT remote control (if installed)        | 26 – Fuel level indicator (if installed)              |

Panel Layout – Moving Map Landscape



- |   |  |
|---|--|
| 1 – 12V power receptacle (if installed) | 14 – Hour meter                                      |
| 2 – Overdrive push button               | 15 – Radio (if installed)                            |
| 3 – Altimeter                           | 16 – ATC transponder (if installed)                  |
| 4 – Engine RPM                          | 17 – Inst. frame for moving map system               |
| 5 – Rotor RPM                           | 18 – Low fuel warning light (if installed)           |
| 6 – Oil pressure                        | 19 – BOOST Warn light (R914)                         |
| 7 – Oil temperature                     | 20 – BOOST Caution light (R914)                      |
| 8 – Cylinder head temperature           | 21 – MAG switches                                    |
| 9 – Air speed indicator                 | 22 – Master/starter switch                           |
| 10 – Manifold pressure gauge (if inst.) | 23 – Trim/brake pressure gauge                       |
| 11 – ELT remote control (if installed)  | 24 – Rotor bearing temperature indication            |
| 12 – Pneumatic mode selector            | 25 – Switches (2 <sup>nd</sup> fuel pump and lights) |
| 13 – GEN and LOW VOLT warning lights    | 26 – Fuel level indicator (if installed)             |

Panel Layout – Moving Map Portrait (Garmin 695)



- |   |  |
|---|--|
| 1 – Engine RPM                            | 14 – Radio   |
| 2 – Overdrive push button                 | 15 – MAG switches                                    |
| 3 – Rotor RPM                             | 16 – Master/starter switch                           |
| 4 – Altimeter                             | 17 – ATC transponder (if installed)                  |
| 5 – Garmin 695                            | 18 – Oil pressure                                    |
| 6 – Inst. frame for Garmin 695            | 19 – Oil temperature                                 |
| 7 – Air speed indicator                   | 20 – Cylinder head temperature                       |
| 8 – Manifold pressure gauge (if inst.)    | 21 – GEN and LOW VOLT warning lights                 |
| 9 – Low fuel warning light (if installed) | 22 – BOOST Warn/Caution light (R914)                 |
| 10 – Fuel level indicator (if installed)  | 23 – Cut-out 2 ¼" for optional installations         |
| 11 – ELT remote control (if installed)    | 24 – Switches (2 <sup>nd</sup> fuel pump and lights) |
| 12 – Pneumatic mode selector              | 25 – Hour meter                                      |
| 13 – Trim/brake pressure gauge            | 26 – 12V plug / 27 – Rotor bearing temp.             |

Panel Layout – Glass Cockpit (FlyMap LD)



- |   |  |
|---|--|
| 1 – 12V power receptacle (if installed) | 12 – Hour meter                                      |
| 2 – Overdrive push button               | 13 – Radio (if installed)                            |
| 3 – FlyMap Integrated Display 1         | 14 – ATC transponder (if installed)                  |
| 4 – Back-up altimeter                   | 15 – Low fuel warning light (if installed)           |
| 5 – Compass (2 ¼" cut-out)              | 16 – BOOST Warn/ Caution light (R914)                |
| 6 – Back-up air speed indicator         | 17 – MAG switches                                    |
| 7 – FlyMap Integrated Display 2         | 18 – Master/starter switch                           |
| 8 – Compass (card type option)          | 19 – Trim/brake pressure gauge                       |
| 9 – ELT remote control (if installed)   | 20 – Rotor bearing temperature indication            |
| 10 – Pneumatic mode selector            | 21 – Switches (2 <sup>nd</sup> fuel pump and lights) |
| 11 – GEN and LOW VOLT warning lights    | 22 – Cut-out 2 ¼" for optional installations         |

### **7.13 Intercom**

The standard intercom system features a socket with bayonet coupling on a loose cable to connect a helmet. The intercom amplifier and VOX control is integrated in the respective radio. See manufacturer's manual for additional information.

### **7.14 Pitot Static**

Total pressure is picked up by a pitot type tube located in the nose section of the fuselage. The tube is connected to the integrated cockpit instruments by a plastic line. Static pressure is measured across two ports, one on either side of the fuselage. In older versions, static pressure is measured through the open ports of the instrumentation, right behind the cockpit panel.

### **7.15 Indicators and Sensors**

Rotor speed is measured by a magnetic pick-up, located directly at the geared ring of the rotor head. Rotor bearing temperature is measured by a temperature sensor which is battery powered.

Other indicators and sensors have been described in the respective paragraphs. For engine related indicators and sensors see the engine manufacturer's manual.

### **7.16 Seats and Seatbelts**

Forward and aft seat consist of a GRP bowl which is fastened to the frame structure. Basic upholstery consists of seat and backrest cushions with foam core and a fabric covering. As an option, an easily cleanable, water-repellent 'sports design' cover is available. The cushions are attached with hook-and-loop tape and press studs. However, if the aft seat is not occupied, the cushions should be removed or properly retained to prevent flutter or loss.

An adjustable four point harness is fitted for each seat. Make sure that the aft seat belt is buckled and tight when flying with the aft seat unoccupied.

### **7.17 Stowage Capacity**

A storage compartment is located in the fuselage nose section which can be accessed by a removable GRP cover. The cover is held by 4 camlock fasteners which can be locked or unlocked by a quarter turn. If loaded, observe weight and balance limitations and make sure luggage does not restrict free movement of the pedals.

INTENTIONALLY LEFT BLANK

## CONTENTS

8.1	Maintenance Obligations .....	8-1
8.2	General .....	8-1
8.3	Ground Handling .....	8-2
8.4	Cleaning .....	8-2
8.5	Refuelling .....	8-2
8.6	Checking of Engine Oil Level.....	8-2
8.7	Checking of Engine Coolant Level.....	8-3
8.8	Tire Pressure.....	8-3
8.9	Lubrication and Greasing.....	8-3
8.10	Replenishing of Fluids .....	8-4
8.10.1	Engine oil.....	8-4
8.10.2	Engine coolant.....	8-4
8.11	Engine Air Filter .....	8-4
8.12	Propeller.....	8-4
8.13	Battery.....	8-4
8.14	Winter Operation .....	8-4
8.15	Removal, Disassembly, Assembly and Installation of the Rotor .....	8-5
8.15.1	Removal of the Rotor System .....	8-5
8.15.2	Disassembly of the Rotor System .....	8-6
8.15.3	Assembly of the Rotor System.....	8-7
8.15.4	Installation of the Rotor System .....	8-8
8.16	Road Transport .....	8-8
8.17	Repairs.....	8-9



INTENTIONALLY LEFT BLANK



## SECTION 8 - HANDLING AND SERVICING

This chapter contains guidelines for correct handling and servicing of the gyroplane, as well as manufacturer recommendations helping to keep its performance, reliability and value.

### 8.1 Maintenance Obligations

According to the German law the owner/operator is responsible to ensure that the aircraft is properly maintained by an authorized facility and continued airworthiness is asserted by a qualified inspector. The supervision of this process has been delegated by the National Authority to the DULV (Deutscher Ultraleichtflugverband e.V.).

All airworthiness limitations, inspections and time limits are described in detail in the maintenance manual. However, for owner/operator's information the intervals for mandatory maintenance events are provided as follows:

- 25 h: "25 h inspection" (one-time / non-recurrent)
- 100 h / 12 months (whatever occurs first): "100 h inspection"
- 12 months: Annual airworthiness review (JNP, Jahresnachprüfung)

For engine maintenance and overhaul, refer to the engine manufacturer's manual.

Special inspections have to be performed by an authorized and qualified maintenance centre or the manufacturer after operational incidents, which are

- Hard landing
- Rotor contact with obstacle
- Propeller contact with obstacle or external impact
- Bird strike
- Lightning strike

If any of the above cases apply, mark the aircraft as 'unserviceable' and consult the manufacturer or an authorized maintenance and repair station before further operation.

Apart from these obligatory inspections and maintenance tasks, the owner/operator is entitled to perform the following preventive and in-between maintenance tasks and checks, as well as exchange of parts and minor repairs:

### 8.2 General

Whenever possible, park the gyroplane in a place where it is protected from direct sunlight, wind and humidity. High humidity, especially in combination with a salt-laden atmosphere will lead to corrosion. The sunlight's ultra-violet radiation and the heat impact on the GRP/CRP components may lead to a degradation of the materials integrity. The manufacturer will take no responsibility for damage or impaired safety margin due to improper treatment.

### 8.3 Ground Handling

Experience shows that aircraft may be exposed to much higher loads when operated on ground, than when in flight. Such loads caused by rumbling on rough terrain, or bouncing the aircraft over the hangar threshold may easily exceed the design load in peak.

Use caution when handling the gyroplane on ground. Do not push at the rudder or at the outer stabilizers. Avoid excessive swing of the rotor blades as repeated bending ultimately leads to fatigue or damage.

### 8.4 Cleaning

Care and regular cleaning of engine, propeller, rotor system and fuselage is the basic foundation for airworthiness and reliability. Therefore, the gyroplane should be cleaned after every last flight of the day or more often, if environmental conditions dictate.

In order to protect the gyroplane against dirt, dust, bird soil, and sunlight, the aircraft should be covered with a light plastic tarpaulin or cloth. Openings to the engine, service access port and airspeed indicator should be closed after the flight (insects, birds etc.).

Contamination can be cleaned with clean water, possibly with mild cleaning additives. To clean the rotor it is best to soak contamination with a cloth or towel, wipe with soft or micro-fibre cloth, and rinse thoroughly with water.

#### CAUTION

**Do not use gasoline or solvents as cleaning agents for the windshields, as it will destroy them irreparably. Do not let windshields sun-dry after washing as they will stain permanently.**

### 8.5 Refuelling

Have aircraft grounded before refuelling. Be aware that most airfield refuelling equipment is laid out for larger diameter tank filler necks and high flow rates. To avoid contamination, use a funnel with strainer and/or filter when refuelling from canisters.

In case where two fuel tanks installed, a crossover line connects both to ensure equal level. In order to top off tanks it is recommended to fill both tanks sequentially as the cross-over flow rate is limited.

#### NOTE

**Do not fill to the absolute maximum in order to allow for thermal expansion of the fuel.**

### 8.6 Checking of Engine Oil Level

Before attempting to check the engine oil level double check that both Magnetos are switched off. The oil level is measured with the aircraft in a level attitude and should be between the marks on the dipstick.

To gain access to the oil reservoir hinge the rear seat forward, open and remove oil reservoir cap and remove dipstick. Turn the engine over using the propeller in the correct sense of rotation until you clearly hear the oil gurgle in the tank.

Insert the cleaned dipstick fully for measurement. Fill up oil according to the engine manufacturer's specification when required. After completion make sure the dip stick is in place and the reservoir cap is back on securely.

**CAUTION**

**Never attempt to turn the engine against its sense of rotation as this may lead to damage.**

### 8.7 Checking of Engine Coolant Level

Between flights, the engine coolant level is checked by verifying the level in the overflow bottle is within min. and max. markings. The coolant level can be easily seen when looking at the transparent overflow bottle from behind.

For additional details concerning this pre-flight check and a description of the more comprehensive daily check procedure, refer to the engine manufacturer's manual.

### 8.8 Tire Pressure

- Main wheels ..... 1.6 bar
- Nose wheel ..... 1.4 bar

### 8.9 Lubrication and Greasing

Between maintenance intervals the owner/operator is entitled to do the following lubrication and greasing:

Component	Interval	Application	Type
Teeter bolt	5 hours	as required	AutoGyro S.VB6007
Pre-rotator drive coupling sleeves	as required	as required	AutoGyro S.VB6006
Pre-rotator belt and pulleys	as required	as required	AutoGyro S.VB6018

**CAUTION**

**Any signs of wear on the teeter tower due to movement of the teeter bolt head indicate a beginning of seizure of the teeter hinge. In most cases the phenomenon is caused by insufficient greasing.**

## 8.10 Replenishing of Fluids

### 8.10.1 Engine oil

See engine manufacturer's manual.

### 8.10.2 Engine coolant

See engine manufacturer's manual.

## 8.11 Engine Air Filter

The air intake filters need to be replaced or cleaned according to the manufacturer's recommendation. Depending on environmental conditions, such as dust, sand, or pollution the recommended rate of maintenance should be increased as required.

## 8.12 Propeller

Clean regularly as contamination will noticeably decrease its efficiency, resulting in a negative effect on both aircraft performance and noise emission. Use either pure water or add mild cleaning additives. Let contamination soak, then remove with a soft cloth or micro fibre material and rinse with enough water. Check for erosion and damage, especially at the leading edge and blade tips. Check tight fit at the propeller blade root or any unusual sound when tapping the blades, in case of a variable pitch propeller. If in doubt or if damage is obvious, consult the aircraft manufacturer or a qualified maintenance station.

## 8.13 Battery

The aircraft is fitted with a maintenance-free gel electrolyte battery. Maintenance is therefore limited to outside soundness, correct attachment, and cleaning. Check integrity of the battery as leaking fluid contains corrosive sulphuric acid which would lead to extensive damage when contacting the framework and attachments.

Charge the battery only with a charging device which is suitable for gel electrolyte batteries.

### **CAUTION**

**The battery must never be deep discharged, as it will be damaged. If so, it might need to be replaced.**

## 8.14 Winter Operation

The cooling system for the cylinder heads of the engine is filled with a mixture of anti-freeze and water, which gives freezing protection down to -20°C. Check protection temperature of the coolant and add anti-freeze, if necessary.

If temperatures are expected to fall below protection temperature, drain the coolant, and if required for service, refill with pure antifreeze. As anti-freeze ages, renew the coolant every two years. Read the engine manual for the manufacturer's recommendations.

During winter operations the necessary operating temperature for oil and cooling agent may not be reached. This can be compensated by taping some portion of the coolers. Monitor all engine temperatures closely after having the coolers taped and modify, if necessary.

When using heated clothing be aware of the electrical power demand in regard to the generator performance. Do not exceed the generator output value in order not to drain the battery. A loss of electric power affects avionics and radio communication and can lead to an engine failure.

Before each flight inspect all bowden cables for free and easy movement and sufficient lubrication.

### 8.15 Removal, Disassembly, Assembly and Installation of the Rotor

In order to transport or park the gyroplane with minimum space requirements, the rotor system can be removed and disassembled, if needed. In order to do so, a second person is needed to assist and help to prevent any damage to the gyroplane or the rotor system.

#### WARNING

**The rotor system must be removed and disassembled for road transport. When handled incorrectly the rotor system can be damaged irreparably. If undetected this may have catastrophic consequences.**

#### CAUTION

**When removing or disassembling make sure to mark all parts so that each and every component of the rotor system is reassembled and installed in exactly the same way and orientation. Some rotor blades have loose washers in them which are required as balance weights. Do not remove or restrain if present!**

#### 8.15.1 Removal of the Rotor System

1. Secure the gyroplane on level ground by engaging the parking brake, adjust the rotor system lengthwise and pump up the rotor brake to its maximum.
2. Remove and discard split pin and unscrew the castellated nut (5). The rotor system has to be tilted onto the black rotor teeter stop.
3. The teeter bolt (1) has to be extracted by using only the hand, not a hammer. If needed tilt the rotor blades carefully onto the teeter stop, in order to prevent the bolt from jamming. Make sure that the rotor stays level in the teeter axis, if not the teeter bolt will damage the Teflon coated bushes, while being pushed out.
4. A supervised second person has to hold the rotor system in flying direction.
5. Lift the rotor system carefully out of the teeter tower and be aware of the position of the shim washers (2). Their thicknesses may differ and it is essential that they are reinstalled on the correct side! They are marked with dots to identify the correct side.
6. Remove the rotor system to one side by letting it rest on your shoulder and take care not to collide with stabilizer or propeller.

7. The shim washers and the teeter block in the hub are marked on each side with either one or two engraved dots. Directly after the disassembly the shim washers need to be fixed on their respective side with cable ties.
8. The rotor system must not be placed on a dirty or grainy surface, as the blades can scratch and damage easily. The best way is to place the rotor blades centrally onto two stands, supporting the rotor at approximately 2 m distance from the hub.

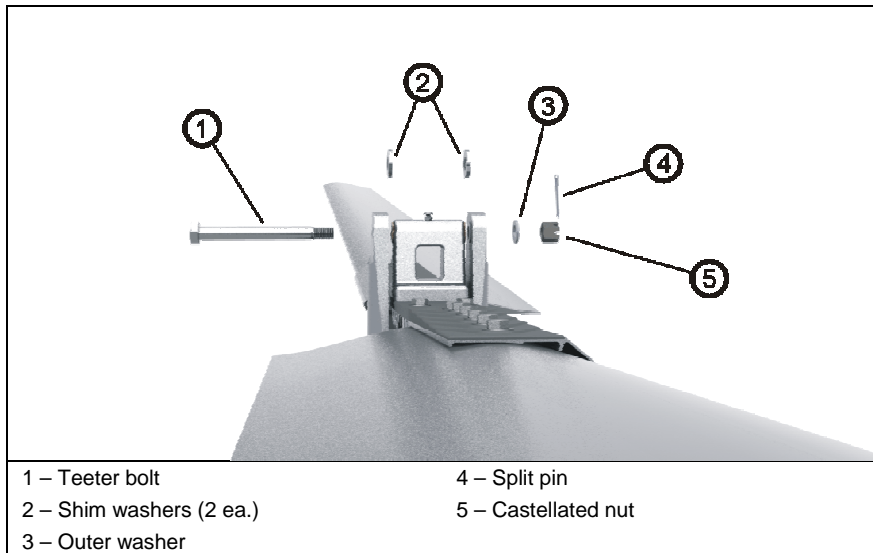

### Handling of the Rotor System

Do not lift or support the rotor system at its blade tips as the bending moment due to the weight of the hub assembly may overstress the blade roots. If possible, handle with two persons while holding approximately in the middle of each blade. When supporting the system use two stands each positioned in about 2 metres distance from the hub.

#### CAUTION

**The assembled rotor system can be damaged irreparably if handled incorrectly. If the rotor system is lifted in a wrong way, its own weight may overstrain the material.**

### 8.15.2 Disassembly of the Rotor System

1. To disassemble the rotor system, place it upside down onto a clean surface or stands to support the rotor at approximately 2 m from the hub.
2. Loosen locknuts (6) on the first blade by counter holding the corresponding bolt head to prevent it from turning inside the blade holes.

3. Push out all fitting bolts (4) without any force, but use no more than a gentle tapping if necessary. Tilt the rotor blade up and down to support easy removal of the bolt.
4. Carefully pull the rotor blade out of the hub (1) in radial direction and take off the clamping profile (2).
5. Repeat step 2 to 4 on second rotor blade.
6. **Do not disassemble the rotor hub!**
7. Store and transport rotor blades, clamping profile and rotor hub only in air cushion foil or using other suitable means to prevent bending or surface damage.

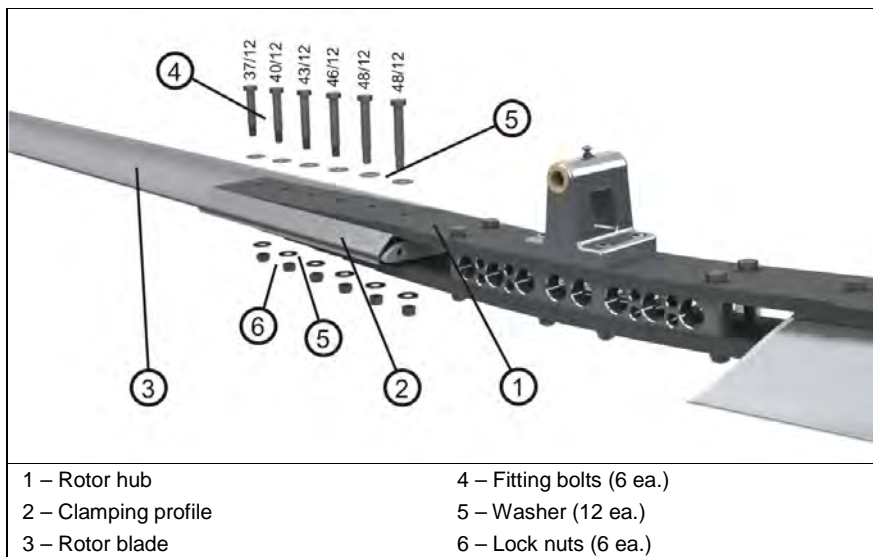

### 8.15.3 Assembly of the Rotor System

1. The rotor blades, clamping profile and rotor hub are labelled with an engraved serial number.
2. Insert the first rotor blade carefully into the clamping profile. Make sure that all serial numbers match.
3. Fit the rotor hub side with the according serial number to clamping profile and blade. Insert fitting bolts without using force so that the bolt end is on top when the rotor system is installed. For re-identification and correct installation position the shaft length is provided in the figure above. Example: 40/12 means shaft length 40mm.
4. Position the washers and the locknut and hand-tighten all nuts.
5. Torque-tighten nuts with 15 Nm from the inside to the outside, using a torque wrench. When doing so, counter-hold bolts to prevent any damage the hub and blade holes.
6. Repeat steps 2 to 5 for the second rotor blade.

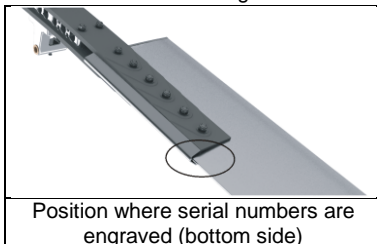

### 8.15.4 Installation of the Rotor System

#### CAUTION

**During installation make sure to have each and every part of the rotor system installed in exactly the same way and orientation as it was before.**

1. Secure the gyroplane on level ground by engaging parking brake, adjust the rotor head or teeter tower corresponding to fore-aft and pressurize the rotor brake up to maximum.
2. Check correct matching of parts: The rotor hub and the teeter tower are marked with two dots according to the orientation for installation.
3. Lift the rotor blade with a second briefed person (one person standing aft, one person standing directly in front of the hub).
4. Approach with the rotor system from the side to the gyroplane and make sure not to collide with propeller or stabilizer. Insert the rotor system into the hub from above while standing on a ladder or the rear seat.
5. The second person can let go, as soon as it is resting centrally in the teeter tower on the teeter stops.
6. Insert teeter bolt by hand in the same orientation as it was before (bolt head should be at that side of the teeter block which is marked with one dot) while matching the shim washers with the corresponding installation positions.
7. Check direction of assembly and shim washers: rotor hub, teeter tower and shim washers are marked on each side with either one or two engraved dots.
8. If the teeter bolt cannot be inserted, tilt the rotor blade along the teeter axis with the free hand.
9. Install washer and castellated nut. Hand-tighten only and secure with a new split pin. Use split pins only once. Make sure that the teeter bolt can be turned easily by hand.

### 8.16 Road Transport

If road transport cannot be avoided, transport with minimum fuel, which reduces airframe loads and prevents fuel spilling through vent pipes.

Tie-down the fuselage using the following procedure:

- Put a wooden block below the lowest point of the keel tube and lash keel tube against wooden block. The block should be dimensioned so that the main wheels are half way unloaded
- Lash down both main wheels through the rims
- Lash down nose wheel through the rim

Furthermore, it is recommended to wrap the gyroplane for road transportation. Especially the rotor blades need to be packed carefully, as even the smallest damages may force the replacement of the complete system.



**WARNING**

The rotor system must be removed and disassembled for road transport. When handled incorrectly the rotor system can be damaged irreparably. If undetected this may have catastrophic consequences.

## 8.17 Repairs

**IMPORTANT NOTE**

Repairs may only be executed by persons authorized by the manufacturer, and in strict compliance with maintenance and repair instructions.



INTENTIONALLY LEFT BLANK



## SECTION 9 - SUPPLEMENTS

### LIST OF SUPPLEMENTS

- 9-1 Variable Pitch Propeller - IVO
- 9-2 Lights
- 9-3 GPS/Moving Map Systems



INTENTIONALLY LEFT BLANK

## 9-1 Variable Pitch Propeller - IVO

### 9-1.1 General

A variable pitch propeller (VPP) manufactured by IVO is available as optional equipment to optimize the propeller efficiency, fuel consumption, and noise in all flight regimes and power settings. This is achieved by changing the propeller pitch.

### 9-1.2 Limitations

No change to standard aircraft

### 9-1.3 Emergency Procedures

Proceed according to generic variable pitch propeller procedure provided in SECTION 3 for the standard aircraft.

### 9-1.4 Normal Procedures

#### 9-1.4.1 Set Propeller to FINE

In order to set the propeller to 'FINE' for start-up, take-off and approach, use the following procedure:

- Press the rocker switch in direction FINE (forward or top position) until end position safety device (circuit breaker) pops out
- Notice pitch change motor buzz (engine off) or increase of engine RPM
- Wait 5 seconds before re-engagement of breaker

#### 9-1.4.2 Adjust Propeller COARSE

- Adjust propeller pitch and throttle to match engine RPM and manifold pressure according to the power setting table below

#### CAUTION

**When adjusting the propeller do not overtorque (i.e. too high MAP for given RPM) the engine as this may lead to overloading, reduced life time or possible damage.**

#### NOTE

**As a safety measure, the mechanical end stop in full COARSE position is chosen to allow a residual climb rate of 1 m/s in standard atmospheric conditions at sea level with a maximum gross weight of 450 kg.**

## 9-1.5 Performance

### ROTAX 912 ULS

Power setting	Engine RPM	MAP	Fuel flow [ltr/h]
Max. TOP	5800	27.5	27
Max. MCP	5500	27	26
75% MCP	5000	26	20
65% MCP	4800	26	18
55% MCP	4300	24	14

### ROTAX 914 UL

Power setting	Engine RPM	MAP	Fuel flow [ltr/h]
Max. TOP	5800	39	33
Max. MCP	5500	35	26
75% MCP	5000	31	20
65% MCP	4800	29	17.5
55% MCP	4300	28	12.5

MAP limits do not apply at engine speeds above 5100 RPM, marked by a yellow triangle at the RPM gauge / engine speed indicator.

#### NOTE

**Above data is valid for standard conditions at sea level. Keep in mind that engine and propeller performance is affected by altitude and temperature. For detailed information refer to the engine manufacturer's and propeller manufacturer's documentation.**

## 9-1.6 Weight and Balance

No change to standard aircraft

## 9-1.7 System Description

The IVO variable pitch propeller is controlled by a spring-loaded rocker switch labelled FINE and COARSE. In most cases the switch is installed behind the throttle quadrant in the left hand seat frame. An automatic fuse is located behind the switch, serving as an end position safety device. Propeller pitch changes continuously as long as the rocker switch is depressed in the respective position. Note that there is no direct angle-of-incidence control or position feedback, besides the mechanical end stops.

Activation of the rocker switch closes an electrical circuit which energizes the electrical pitch control motor inside the propeller hub through brushes running on a collector ring. The electrical motor drives a mechanical gear which is connected to torsion tubes running inside the propeller blades. Actual blade feathering motion is achieved by twisting the complete blade, without having the need for a pitch change bearing.

### **9-1.8 Handling and Servicing**

Refer to the manufacturer's documentation.



INTENTIONALLY LEFT BLANK



## **9-2 Lights**

### **9-2.1 General**

Depending on customer's configuration the gyroplane can be equipped with optional

- Landing lights
- Navigation /position lights
- Strobe lights

### **9-2.2 Limitations**

No change to standard aircraft

### **9-2.3 Emergency Procedures**

No change to standard aircraft

### **9-2.4 Normal Procedures**

The lights can be switched on or off by respective switches in the centre panel, labelled

- "Light" for landing light
- "Nav" for navigation/position lights
- "Strobe" for strobe lights

Due to their small silhouette gyroplanes are easily overlooked, especially if approached directly from behind, such as on approach. It is therefore highly recommended that navigation and strobe lights are switched on during flight.

### **9-2.5 Performance**

No change to standard aircraft

### **9-2.6 Weight and Balance**

No change to standard aircraft

### **9-2.7 System Description**

Navigation and strobe lights are installed as combined units at the left hand and right hand side of the fuselage, behind the passenger station. The landing light consists of a pair of lamps installed in the nose. Note that the conventional lights have a considerably higher power demand over those with LED technology. In case of generator or battery malfunction ("Gen" or "Low Volt" indication on) it is even more essential to switch these lights off in order to preserve electrical power.

### **9-2.8 Handling and Servicing**

No change to standard aircraft

INTENTIONALLY LEFT BLANK

## 9-3 GPS/Moving Map Systems

### 9-3.1 General

Depending on customer's configuration the gyroplane can be equipped with different GPS/Moving Map Systems as optional equipment.

#### NOTE

**Any moving map system shall be used for reference only and does not replace proper flight planning and constant oversight and awareness.**

### 9-3.2 through 9-3.6

No change to standard aircraft

### 9-3.7 System Description

Refer to the manufacturer's documentation.

### 9-3.8 Handling and Servicing

Refer to the manufacturer's documentation.



INTENTIONALLY LEFT BLANK

## CONTENTS

Low-G Avoidance.....	10-1
Side Slip in Gyroplanes.....	10-1
Flying Low on Fuel Is Dangerous.....	10-2
Do Not Push the Envelope and Remain Easy On the Controls.....	10-2
Strobe Lights On – For Your Own and Other’s Safety.....	10-2
Propellers and Rotors Can Be Extremely Dangerous.....	10-2
Power Lines and Cables Are Deadly.....	10-2
Loss of Visibility Can Be Fatal.....	10-2
Overconfidence Prevails in Accidents.....	10-3
Flying Low over Water is Very Hazardous.....	10-3
Conversion Pilots Constitute High Risk When Flying Gyroplanes.....	10-3
Beware of Demonstration or Initial Training Flights.....	10-4
Training Off-Field Simulated Engine Failures.....	10-4

INTENTIONALLY LEFT BLANK

## SECTION 10 - SAFETY TIPS

### General

This section provides miscellaneous suggestions and guidance to help the pilot operate the gyroplane more safely.

### Low-G Avoidance

Never push the control stick forward to descend or to terminate a pull-up (as you would in an airplane). This may produce a low-G (near weightless) condition which can result in a situation with reduced or lost lateral roll control and significant loss of main rotor RPM. Always reduce power to initiate a descent.

### Side Slip in Gyroplanes

Excessive side slip has to be avoided at all means. Side slip can be safely performed up to the degree which is necessary for proper runway alignment for landing within crosswind limitations. Excessive side slip starts at a point where de-stabilizing effects of the fuselage balance out or even supersede the stabilizing effects of the stabilizer. Pilots being new to gyroplanes, especially those with fixed wing experience may not be aware of these physical limitations. When exceeding these limitations, be it by imitating 'professionals' or applying habits and control schemes from fixed wing aircraft, the gyroplane may enter an attitude where it is not recoverable any more. As the pedal control is rather sensitive and alignment is crucial in high-performing gyroplanes, pilots should develop a feeling for side slip and 'automatized feet' in order to maintain aerodynamic alignment and to compensate for power-induced yaw couplings by anticipation as a conditioned reflex.

**A note to training facilities and flight instructors:** Due to their reduced directional stability, gyroplanes require active control to enter, stabilize and neutralize side slip. Most students perceive natural discomfort in side slip. Depending on the situation, students may erroneously make a wrong control input or freeze, especially when overchallenged, stressed, or surprised by the situation. In our opinion flight training should focus on the necessity of correct alignment, the training of recovery procedures, and the development of the right reflexes. Intentional side slip training as a normal procedure is considered to be critical as there is no instrument to indicate 'safe' boundaries. An experienced pilot may tell from an imminent change in control response when limits are approached. A student, however, may unknowingly or inadvertently overshoot the limits, especially when he is overly focussed on the touch-down zone and coming in too high.

Side slip may be performed as a part of the emergency training only, and within safe boundaries. The student must be briefed

- to use gentle pedal input for initiation and stabilization
- initiate side slip at or below 90 km/h and maintain air speed by using his perception of speed, respectively speed sensation (for want of a working air speed indication)
- not to rely on airspeed indication in side slip
- never to perform abrupt control stick input into the direction of motion (to chase a faulty speed indication)

It is highly advisable that the instructor remains light on the controls at all times.

## **Flying Low on Fuel Is Dangerous**

Never intentionally allow the fuel level to become critically low. Although a gyroplane leaves much more options than a fixed wing aircraft and is easier to control during power-off than a helicopter, a forced landing into unknown terrain always poses unnecessary and unpredictable risk with danger to material, health, or life.

## **Do Not Push the Envelope and Remain Easy On the Controls**

Avoid abrupt control inputs or accelerated manoeuvres, particularly at high speed. These produce high fatigue loads in the dynamic components and could cause a premature and catastrophic failure of a critical component.

## **Strobe Lights On – For Your Own and Other’s Safety**

Turn the strobe lights (if installed) on before starting the engine and leave it on until the rotor stops turning. The strobe lights are located near the propeller and provide a warning to ground personnel. Leaving them on in flight is also advisable since the gyroplane may be difficult for other aircraft to see.

## **Propellers and Rotors Can Be Extremely Dangerous**

Never attempt to start the engine until the area around the propeller is completely clear of any persons or objects. Do not start the engine while standing beside the aircraft as you will easily be struck by the propeller in case of a brake failure or an operating error.

Be sure ground personnel or onlookers don't walk into the propeller or main rotor. Mind the spinning rotor and propeller when taxiing close to obstructions or persons. It is advisable to maintain at least one rotor diameter distance from obstructions or persons when taxiing with spinning rotor. A fast turning rotor is almost invisible, but may contain enough energy to kill a person.

Never let go of the control stick and make sure the rotor blades spin down in level/horizontal attitude until the rotor is at a complete stop. Wind or negligent behaviour on the control stick may cause the blades to flap dangerously low and hit control stops, stabilizer, or people.

## **Power Lines and Cables Are Deadly**

Flying into wires, cables, and other objects is by far the number one cause of fatal accidents in rotary wing aircraft. Pilots must constantly be on the alert for this very real hazard.

- Watch for the towers; you will not see the wires in time
- Fly directly over the towers when crossing power lines
- Allow for the smaller, usually invisible, grounding wire(s) which are well above the larger more visible wires
- Constantly scan the higher terrain on either side of your flight path for towers
- Always maintain at least 500 feet AGL except during take-off and landing. By always flying above 500 feet AGL

## **Loss of Visibility Can Be Fatal**

Flying a gyroplane in obscured visibility due to fog, snow, low ceiling, or even a dark night can be fatal. Gyroplanes have less inherent stability and much faster roll and pitch rates than airplanes. Loss of the pilot's outside visual references, even for a moment, can result in disorientation, wrong control inputs, and an uncontrolled crash. This type of situation is



likely to occur when a pilot attempts to fly through a partially obscured area and realizes too late that he is losing visibility. He loses control of the gyroplane when he attempts a turn to regain visibility but is unable to complete the turn without visual references.

You must take corrective action before visibility is lost! Remember, a precautionary landing in a gyroplane will always be safer than a flight with impaired or no visibility.

### **Overconfidence Prevails in Accidents**

A personal trait most often found in pilots having serious accidents is overconfidence. High-time fixed-wing pilots converting to gyroplanes and private owners are particularly susceptible. Airplane pilots feel confident and relaxed in the air, but have not yet developed the control feel, coordination, and sensitivity demanded by a gyroplane. Private owners must depend on self-discipline, which is sometimes forgotten. When flown properly and conservatively, gyroplanes are potentially the safest aircraft built. But especially gyroplanes also allow little tolerance when flown to their limits. Gyroplanes must always be flown defensively.

### **Flying Low over Water is Very Hazardous**

Accidents repeatedly occur while manoeuvring low over water. Many pilots do not realize their loss of depth perception when flying over water. Flying over calm glassy water is particularly dangerous, but even choppy water, with its constantly varying surface, interferes with normal depth perception and may cause a pilot to misjudge his height above the water.

**MAINTAIN SAFETY ALTITUDE At ALL TIMES**

### **Conversion Pilots Constitute High Risk When Flying Gyroplanes**

There have been a number of fatal accidents involving experienced pilots who have many hours in airplanes or helicopters but with only limited experience flying gyroplanes.

The ingrained reactions and habits of an experienced airplane pilot can be deadly when flying a gyroplane. The airplane pilot may fly the gyroplane well when doing normal manoeuvres under ordinary conditions when there is time to think about the proper control response. But when required to react suddenly under unexpected circumstances, he may revert to his airplane reactions and commit a fatal error. Under those conditions, his hands and feet move purely by reaction without conscious thought. Those reactions may well be based on his greater experience, i.e., the reactions developed flying airplanes.

For example, in an airplane his reaction to an engine failure would be to immediately and considerably go forward with the stick or horn. In a gyroplane, application of inadequate forward stick could result in a low-G situation or, if the engine failure occurred during initial climb, a reduction of rotor RPM combined with a high sink rate with the consequence of a hard landing or impact.

Airplane pilots may also underestimate pedal work. Especially in a gyroplane, pedal control is most critical as it has the highest rate response with the smallest static and dynamic damping effect of all other controls. On top of that, power-yaw coupling is much more predominant than in an airplane. Being used to the high directional stability of an airplane, a conversion pilot may neglect proper pedal work and, which is much worse, assume side slip limits at the pedal stop. Very much like helicopters, gyroplanes cannot be flown by control position or control force, but solely by resulting attitude. That means that the pilot together

with his built-in senses and programmed reflexes represents a vital part in the active control feedback loop.

Helicopter pilots, on the other hand, may underestimate the characteristics of gyroplanes and the necessity for proper training. The simplicity of design may lead them to the assumption that gyroplanes are easy to fly throughout the envelope. Even helicopter pilots that do not 'look down' on gyroplanes and take it serious may confuse throttle control (push for power) with the control sense of a collective pitch (pull for power) in a stress situation.

To develop safe gyroplane reactions, conversion pilots must practice each procedure over and over again with a competent instructor until hands and feet will always make the right move without requiring conscious thought. **AND, ABOVE ALL, HE MUST NEVER ABRUPTLY PUSH THE CONTROL STICK FORWARD.**

### **Beware of Demonstration or Initial Training Flights**

A disproportionate number of fatal and non-fatal accidents occur during demonstration or initial training flights. The accidents occur because individuals other than the pilot are allowed to manipulate the controls without being properly prepared or indoctrinated.

If a student begins to lose control of the aircraft, an experienced flight instructor can easily regain control provided the student does not make any large or abrupt control movements. If, however, the student becomes momentarily confused and makes a sudden large control input in the wrong direction, even the most experienced instructor may not be able to recover control. Instructors are usually prepared to handle the situation where the student loses control and does nothing, but they are seldom prepared for the student who loses control and does the wrong thing.

Before allowing someone to touch the controls of the aircraft, they must be thoroughly indoctrinated concerning the sensitivity of the controls in a gyroplane. They must be firmly instructed to never make a large or sudden movement with the controls. And, the pilot-in-command must be prepared to instantly grip the controls should the student start to make a wrong move.

### **Training Off-Field Simulated Engine Failures**

**Pilots:** Besides legal aspects, never train off-field simulated engine failures on your own!

**Instructors:** Always check an area for wires or other obstructions before simulating engine failures. Consider go-around path and the suitability for an actual engine off touch-down. Cut the throttle smoothly and keep control of engine idle RPM to avoid actual engine starvation.

## **APPENDIX**

### **LIST OF APPENDICES**

Operator Registration Form  
Customer Feedback Form  
Incident Reporting Form

INTENTIONALLY LEFT BLANK



Use this form to register as (new) operator / owner, in order to receive safety and service related information concerning your aircraft. The information is stored in a database and is only used within AutoGyro GmbH for the above purpose.

Without proper and timely registration, the operator will not receive vital information, which may lead to unsafe flight or an un-airworthy aircraft.

Return this form to:  
AutoGyro GmbH  
Dornierstraße 14  
31137 Hildesheim or email to [info@auto-gyro.com](mailto:info@auto-gyro.com)

Aircraft Type:	Serial Number (Werk-Nr.):	Registered at: (Airworthiness authority)
----------------	---------------------------	---

Registration / Call Sign:	Year of manufacture:	Engine Type:
---------------------------	----------------------	--------------

Airframe S/N:	Rotor System S/N:	Engine S/N:
---------------	-------------------	-------------

Airframe hours:	Rotor System hours:	Engine hours:
-----------------	---------------------	---------------

Previous Owner (if applicable) - please state name, full address, phone and email

Signature and Date

New/current Owner - please state name, full address, phone and email

Email

Signature and Date

*Below fields are used for AutoGyro internal processing – do not fill in!*

Data entered onto database  
(by / when)

Acknowledgement sent (date)  
(by / when)





<p>Customer's feedback is important to AutoGyro's Technical Publication team.</p> <p>This manual and all information herein have been compiled with greatest care and a maximum level of clarity, safety, and user-friendliness in mind. However, we welcome any comments, questions or suggestions that help us provide a higher quality of our documentation, services, and products.</p> <p>All submitted feedback forms will be processed internally. We are committed to providing a response within ten working days of receipt.</p>		
<p>Return this form to: AutoGyro GmbH Dornierstraße 14 31137 Hildesheim      or email to <a href="mailto:info@auto-gyro.com">info@auto-gyro.com</a></p>		
Document	Issue/Version	Page / Chapter
Product - specify type, year of manufacturing, and serial number ( if applicable)		
Other subject		
Your feedback or error reporting - use extra sheets if needed and include a suggestion for correction or remedial action, if possible		
Reported by		
Email	Date	
<i>Below fields are used for AutoGyro internal processing – do not fill in!</i>		
Investigation completed	Action and response	Internal reference







This form is supplied to enable the owner/operator to inform (anonymously, if needed) AutoGyro GmbH of any incident, accident, or other field or service failure that they feel appropriate. The owner must also, of course, inform the relevant authorities if that is appropriate, e.g. Air Accident Investigation Branch etc.

Depending on the incident information supplied, a corrective action is investigated and, if needed, supplied back to the customer(s).

The information is stored in a database and is only used within AutoGyro GmbH for the above purpose.

Return this form to:  
AutoGyro GmbH  
Dornierstraße 14  
31137 Hildesheim or email to [info@auto-gyro.com](mailto:info@auto-gyro.com)

Aircraft Type:	Serial Number (Werk-Nr.):	Registered at: (Airworthiness authority)
----------------	---------------------------	---

Registration / Call Sign:	Year of manufacture:	Engine Type:
---------------------------	----------------------	--------------

Airframe S/N:	Rotor System S/N:	Engine S/N:
---------------	-------------------	-------------

Airframe hours:	Rotor System hours:	Engine hours:
-----------------	---------------------	---------------

Description of incident (be as precise as possible and use extra sheets if needed)

Incident reported by (information is only stored for further inquiry and deleted after investigation)

Email

Signature and Date

*Below fields are used for AutoGyro internal processing – do not fill in!*

Investigation completed

Corrective action

Internal reference

